



Edelbrock E-Force Supercharger
2011-2013 Ford Mustang 5.0L
Part #'s: 1588 & 1589



Edelbrock Supercharger System 2011-2013 Ford Mustang 5.0L

Installation Instructions

INTRODUCTION

Thank you for purchasing the Edelbrock 5.0L Ford Supercharger System for the Mustang GT. The Edelbrock E-Force Supercharger System for the 2011-2013 5.0L 3V Mustang utilizes Eaton's new Gen VI TVS Supercharger rotors, featuring a four lobe design with a full 160° of twist for maximum flow, minimum temperature rise, quiet operation, and the reliability for which Eaton is known. These rotors however, are merely the foundation of the system. The Edelbrock Supercharger is a complete system that maximizes efficiency and performance by minimizing air restriction into, and out of, the supercharger. This results in maximum airflow, with minimum temperature rise and minimum power consumption. In addition, Edelbrock inverted the supercharger and packaged it down low in the valley, allowing for an incredible, industry leading, 15 inches of runner length, maximizing low end torque. The supercharger housing itself is integrated into the intake manifold for a seamless design with minimal components, eliminating the possibility of vacuum leaks between gasket surfaces. The system also utilizes a front drive, front inlet configuration giving it the shortest, least restrictive inlet path on the market. Sitting right above the supercharger and below the enormous runners is the largest air to water intercooler available, measuring an astonishing 110 square inches. Last but not least, the uniquely styled plenum of the E-Force supercharger makes it, without a doubt, the best looking engine compartment upgrade imaginable. In summation, the Edelbrock supercharger will provide you with the most power at the lowest amount of boost resulting in neck snapping performance that is safe to operate on a completely stock engine. It is also 50 state emissions legal, and can be had with an optional 5 yr 60,000 mile warranty so that there are no worries when installing it on your brand new car.

TOOLS REQUIRED

- Jack and Jack Stands
- **OR** Service Lift
- Panel Puller
- Ratchet and Socket Set including 7mm, 8mm (deep), 10mm, 10mm (deep), 12mm, 13mm, 15mm
- 5mm & 6mm Allen Sockets
- 19mm Wrench
- 3/8" Breaker Bar
- Screwdrivers
- 90° Power Drill
- 1.125" Hole-Saw Bit
- Pliers
- **OR** Hose Clamp Pliers
- Impact Wrench
- 90° Pick
- Blue Loctite
- O-ring Lube
- Masking Tape
- 90° Drill
- .250" Drill bit or 1" Stepped Drill Bit
- Torque Wrench

Edelbrock LLC, 2700 California Street, Torrance, CA 90503
Toll-Free Tech Line: 1-800-416-8628
Office: 310-781-2222



**Edelbrock Supercharger System
2011-2013 Ford Mustang 5.0L**

Installation Instructions

IMPORTANT WARNINGS

Before beginning installation, use the enclosed checklist to verify that all components are present in the box then inspect each component for damage that may have occurred in transit. If any parts are missing or damaged, contact Edelbrock Technical Support, not your parts distributor.



WARNING: Installation of this supercharger will result in a significant change to the performance characteristics of your vehicle. It is highly recommended that you take some time to familiarize yourself with the added power, and how it is delivered, in a controlled environment. Take extra care on wet and slippery roads, as the rear tires will be more likely to lose traction, with the added power. It is never recommended to turn off your vehicles traction control system.

Proper installation is the responsibility of the installer. Improper installation will void all manufacture's standard warranties and may result in poor performance and engine or vehicle damage.

Due to the complexity of the Edelbrock E-Force Supercharging system, it is recommended that this system only be installed by a qualified professional with access to a service lift, pneumatic tools, and a strong familiarity with automotive service procedures. To qualify for the optional supplemental warranty, it is necessary to have this system installed by a Certified ASE Technician, GM Dealership, or an Authorized Edelbrock Installer. Failure to do so will void and/or disqualify any and all optional supplemental warranties offered with this system. Please contact the Edelbrock Technical Support department if you have any questions regarding this system and/or how your installer of choice will affect any warranty coverage for which your vehicle may qualify.

Any previously installed aftermarket tuning equipment must be removed and the vehicle returned to an as stock condition before installing the supercharger.

Any equipment that directly modifies the fuel mixture or ignition timing of the engine can cause severe engine damage if used in conjunction with the Edelbrock E-Force Supercharger System. This includes, but is not limited to: ignition boxes, air/fuel controllers, OBDII programmers, and any other device that modifies signals to and/or from the ECU. Aftermarket bolt-on equipment such as underdrive pulleys or air intake kits will also conflict with the operation of the supercharger and must be removed prior to installation. Use of any of these products with the E-Force Supercharger could result in severe engine damage.

Edelbrock periodically releases improved versions of the calibration file found on the supplied handheld programmer. Check the website to ensure you have the latest version, as described in step #111.



**Edelbrock Supercharger System
2011-2013 Ford Mustang 5.0L**

Installation Instructions

IMPORTANT WARNINGS (CONTINUE)

The supercharger manifold includes a 1/8 NPT port to accommodate the installation of a boost gauge or pressure transducer. Remove the plug and replace it with a fitting to attach your gauge or sensor.

The supercharger has been pre-drilled and tapped for a 1/8" NPT fitting at the rear of the passenger side intake runner flange. There is currently a plug sealing the hole, which can be removed, and replaced with a fitting to adapt to your sensor. **CAUTION:** Never cut into the vacuum lines leading to the bypass actuator, on the driver's side of the manifold, for the purpose of tapping in a boost gauge, as this will result in boost pressure readings that are higher than what is actually present in the intake plenum.

Do not use a wideband oxygen sensor in place of the rear O2 sensor when dyno testing this supercharger system. The voltage signal will cause the fuel system to run lean and possible engine damage.



91 octane or higher gasoline is required at all times. If your vehicle has been filled with anything less, it must be run until dry and refilled with 91 or higher octane gasoline twice prior to installation.

Failure to use the required 91 octane gasoline or higher could permanently damage your engine. Any failures associated with not using premium 91 octane gasoline or higher, will be ineligible for warranty repairs.

Installation Instructions

INSTALLATION HARDWARE PARTS LIST

Hardware Bag #1



(1x) - Plastic Firewall Plug



(8x) - Fuel Injector Clip



(16x) - M6 x 1.0 x 12mm
Hex Flange Bolt



(14x) - M6 x 1.0 x 30mm
Hex Flange Bolt

NOTE: A 10mm Quick Connect hose fitting is also included in this bag, but not shown)

Hardware Bag #3



(1x) - M10 x 1.5 x 45mm
Socket Head Bolt



(1x) - M6 x 1.0 x 16mm
Hex Flange Bolt



(1x) - M8 x 1.25 x 25mm
Countersunk Bolt



(1x) - M8 x 1.25 x 20mm
Socket Head Bolt



(1x) - M10 x 1.5 x 65mm Hex Flange Bolt



(3x) - M8 x 22mm Washer



(1x) - M8 x 1.25 x 20mm
Hex Flange Bolt



(2x) - M8 x 1.25 x 90mm Socket Head Bolt



(1x) - Brass Shim



(1x) - A/C Hard Line Bracket



(1x) - M10 x 1.5 x 110mm Hex Flange Bolt



(1x) - M8 x 1.25 x 40mm
Socket Head Bolt

NOTE: A drill and tap for the front engine cover are also included in this bag, but not shown)

Hardware Bag #5



(2x) - M8 x 1.25 x 30mm Hex Flange Bolt



(2x) - M8 x 22mm Washer



(2x) - M8 x 1.25 Hex Flange Nut



Edelbrock Supercharger System 2011-2013 Ford Mustang 5.0L

Installation Instructions

Hardware Bag #7

NOTE: One M6 x.0 x 16mm Hex Bolt and two Metric Zinc Plated Nuts are included in this bag, but not shown)

HOSE IDENTIFICATION GUIDE





Edelbrock Supercharger System 2011-2013 Ford Mustang 5.0L

Installation Instructions

WIRE HARNESS GUIDE

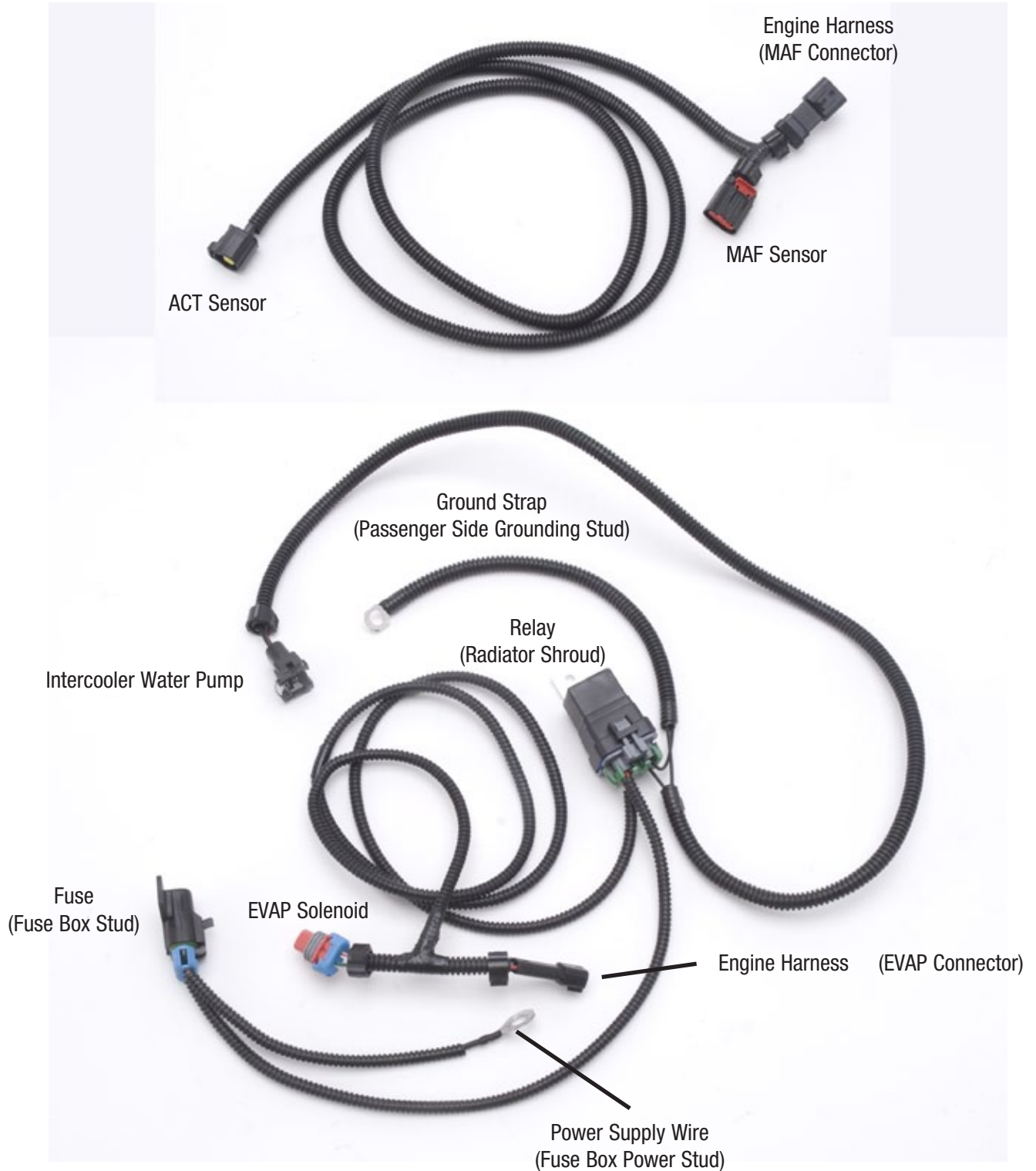



Edelbrock Supercharger System 2011-2013 Ford Mustang 5.0L

Installation Instructions

Test Flash Procedure

Verify that your vehicle's ECU & the supplied programmer are up to date, then use the programmer to flash the ECU thus verifying that they are compatible

- Original Equipment Manufacturers often release updates to the computer programming for your vehicle. Edelbrock highly recommends that you verify, with your new car dealer, that your vehicle is equipped with the latest software version from your vehicle manufacturer, before attempting to load the Edelbrock tune.
- Confirm that you have the latest calibration by checking the Edelbrock website (http://www.edelbrock.com/automotive_new/mc/superchargers/software-tech.shtml) Once you have found the latest tune on the site, power on the programmer, press the left arrow and select the Device Info option. Scroll down to Tune Version and compare that number to the one on the site. If they are different, download the new calibration as instructed on the website.
- Put the car into Acc mode, but don't start the vehicle.
- Connect the supplied PCM cable to the OBD-II connector located below the steering wheel and to the left of your knee.
- Use directional pad to highlight Program Vehicle option and press Select button.
- Use directional pad to highlight Preprogrammed Tune option and press Select button.
- Read disclaimer then press Select to continue.
- Verify ignition is in the 'Key On' position but that the engine is not running then press Select.
- Use directional pad to highlight your vehicle and transmission combination then press Select.
- Use directional pad to highlight Begin Program then press Select.

- Depending on your specific drivetrain configuration, several separate operations may take place during this step. Completion of each operation will cause the progress bar to reset to zero.

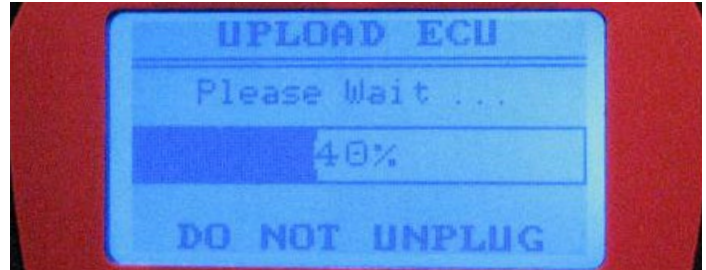

DO NOT unplug the programmer until prompted.

- Turn the car off when prompted to do so by the handheld programmer.
- Read parting message from programmer then press Select to continue.
- Unplug the programmer cable from the OBD-II port.
- In the rare occurrence that you encounter an error message during the test flash procedure, please refer to pg. 22, titled Email Edelbrock Your Stock PCM Calibration.

-
- Post Successful Test Flash
 - If you are ready to install the supercharger, proceed to Step 1 of the Supercharger Installation

OR

- If you wish to return the ECU back to the factory calibration, such that the vehicle can still be driven until you are ready to begin the installation, then:
 - Put the car into Acc mode, but don't start the vehicle.
 - Connect the supplied PCM cable to the OBD-II connector.
 - Use directional pad to highlight Program Vehicle option and press Select button.
 - Use directional pad to highlight Return To Stock option and press Select button.



Edelbrock Supercharger System 2011-2013 Ford Mustang 5.0L

Installation Instructions

- Follow the on screen instructions. Turn the car off when prompted to do so by the handheld programmer.
- Read parting message from programmer then press Select to continue.
- Unplug the programmer cable from the OBD-II port.
- When you are ready to Install the supercharger, proceed with Step 1 and you will be prompted to re-flash the ECU towards the end of the installation procedure.

Supercharger Installation

1. Use an 8mm socket to remove the negative and position battery terminals. Tuck the terminals to the side to prevent any accidental contact with the battery terminals.
2. Remove the front strut tower brace using a 13mm socket (if equipped).
3. Gently lift the engine cover to remove and set aside.
4. Use a flat blade screwdriver to pry up the head of the eight push-pins that retain the radiator shroud, then use a panel puller to fully remove the push-pins. Lift the shroud off the car and set it and the push-pins aside.



5. Using an 8mm socket, remove two (2) 2011-12 upper fascia bolts located between the headlights over the grill



NOTE: 2013 M.Y. will have four (4) bolts and four (4) push pins.



NOTE: Step 6 only applies to 2013 M.Y. vehicles. Disregard otherwise.

6. Remove the grill support by removing two (2) bolts using a 10mm socket. Then use a panel puller to disengage the two push pins on the right and left tabs.

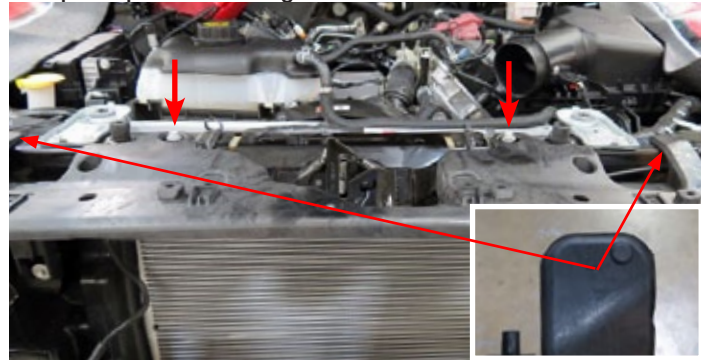

7. Raise the front of the vehicle using a service lift or equivalent. Remove the nine (9) bolts retaining the lower splash shield with a 7mm socket (**2013 M.Y. will have seventeen (17) retaining bolts**). Pull down slightly on the shield to disengage the clips and remove it.





Edelbrock Supercharger System 2011-2013 Ford Mustang 5.0L

Installation Instructions

8. Use a 7mm socket to remove the two (2) bolts from the bottom, leading edge of each front wheel well (**2013 M.Y. will have three (3) bolts**).



9. Remove the five push pins retaining the front half of both front wheel well liners. Note that the two top pins pass through both the front and rear liners. Remove the front half of the liner on both sides of the car.

10. Reach behind the fascia to disconnect the parking lamp connectors on both sides of the vehicle.



11. Detach the ambient air temperature sensor from its bracket at the front of the car then lower the car.

12. Pull the top, rear corners of the fascia away from the fender until the two clips on each side disengage.



13. Lift the two top fascia tabs over the lock clips near the headlights then pull the fascia forward slightly to access the driving light connectors. Using a 90° pick, disconnect the driving light connectors and remove the front fascia and set aside.



14. Detach the driver side PCV hose from the air inlet tube and the valve cover then set it aside for reuse later.



15. Use a 10mm socket to remove the bolt retaining the induction roar resonator diaphragm and lift it up to pull the induction roar resonator tube out of the firewall. Insert the grommet supplied in Bag #1 in the hole left in the firewall. Pull the tube bracket off of the strut tower and the air box.





Edelbrock Supercharger System 2011-2013 Ford Mustang 5.0L

Installation Instructions

16. Loosen the throttle body and air box cover worm clamps then remove and discard the inlet tube assembly. Vehicles equipped with an automatic transmission will also need to detach the brake booster hose from the tube.

17. Disconnect and discard passenger side PCV tube.



18. Disconnect the EVAP solenoid connector at the top of the throttle body flange on the manifold.

19. Use an 8mm socket to remove the two bolts retaining the EVAP solenoid then squeeze the tabs to disconnect the EVAP tube. Set the solenoid aside for reuse later.



20. Remove the EVAP tube by detaching the fitting on the end of the brake booster line near the brake booster. Use both hands to carefully pull up and then outward on the retaining clip. The clip will disengage allowing the fitting and hose to be removed. This hose will not be reused.

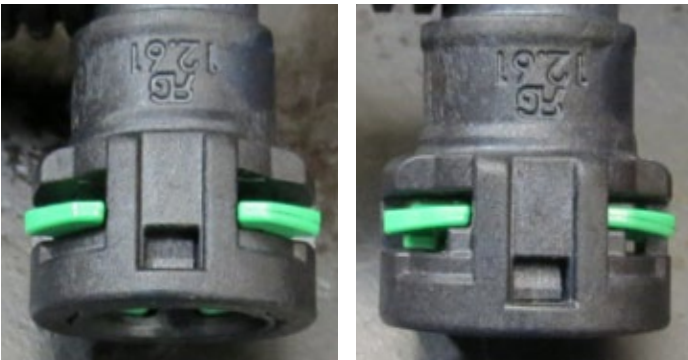

21. Use a 10mm socket (2013 M.Y. use 8mm socket) to remove the four (4) throttle body bolts and then disconnect the throttle body sensor plug. Set the throttle body aside for reuse.



22. Use a 10mm socket to remove the four nuts at the top of the manifold.



23. Disconnect the brake booster hose from the booster and the manifold and set it aside for reuse later.

WARNING: Ensure that the engine has fully cooled before proceeding.

24. Release any excess pressure in the cooling system by using a cloth to rotate the radiator cap counter clockwise then remove the cap.

25. Place a drain pan below the passenger side radiator petcock then use a 19mm wrench to loosen the petcock and drain the engine coolant. The system only needs to be drained until the water level is below the intake flange.



Edelbrock Supercharger System 2011-2013 Ford Mustang 5.0L

Installation Instructions

26. Detach the two heater hoses and the coolant overflow hose from the front of the engine.

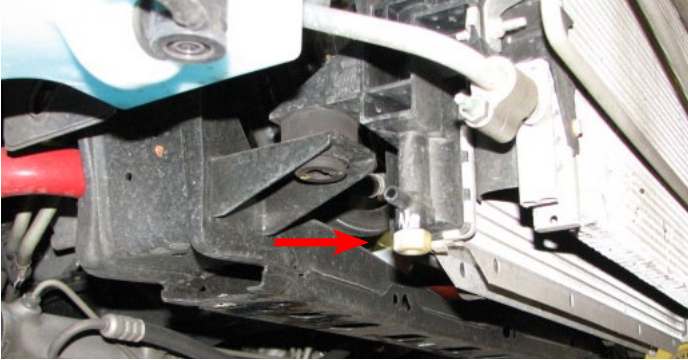

27. Remove the two foam fuel rail bumpers from the top of the manifold and discard them.

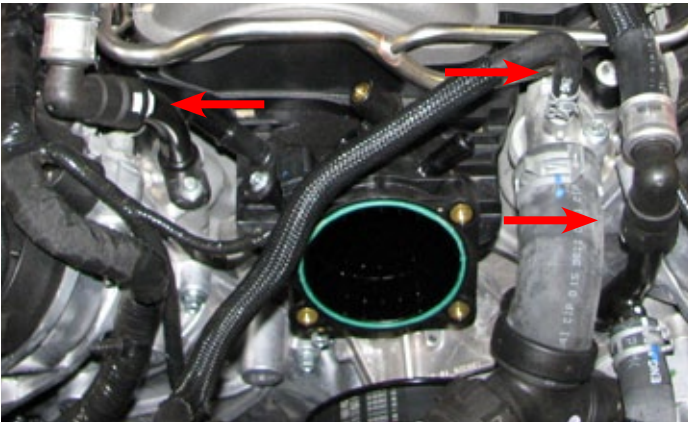

28. Detach the fuel injector electrical connectors.

29. Place a shop rag around the fuel line fitting to absorb excess gas then depress the blue lock tab and pull the fuel line off the rail. Use caution when removing this hose as the fuel is still under pressure and will spray a bit.



30. Use a 10mm socket to remove four (4) fuel rail bolts, then lift the injectors out of their provisions. The rails and injectors will not be reused.

31. Use an 8mm socket to remove six (6) manifold bolts (there are a total of ten (10) manifold bolts, four (4) of which were removed in the previous step).

32. Lift the manifold and temporary place shop towels in each cylinder head port. Carefully detach the wiring harness secured to the manifold with three (3) retaining clips. Remove the manifold and set aside.

33. Carefully remove eight O-ring seals from the manifold flanges and set them aside for reuse later.

34. Use an 8mm socket to remove the bolt retaining the passenger side coolant nipple. Pull the nipple out of the cylinder head and set it aside for reuse later.

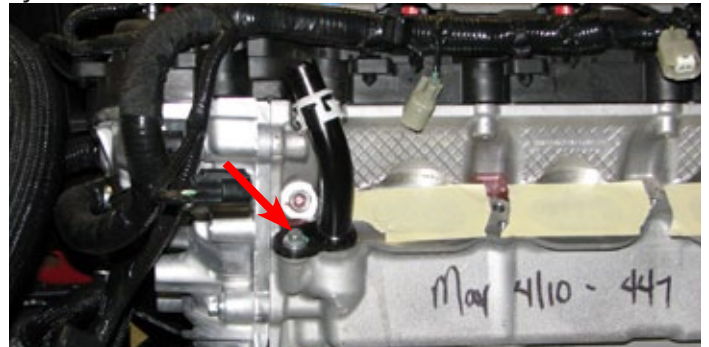

35. Use a soft cloth to remove any contaminants on the sealing surfaces of the cylinder heads. Use masking tape to prevent any debris from entering the exposed ports.





Edelbrock Supercharger System 2011-2013 Ford Mustang 5.0L

Installation Instructions

36. Use a panel puller to remove the four pins retaining the foam bumper, then set them and the bumper aside.



37. Remove the plastic deflectors located on each side of the radiator by removing the plastic retaining clips with a panel puller. 2013 M.Y. need to remove a bolt from the plastic support block using a 8mm socket and then proceed by removing the retaining clips to completely remove each deflector. 2013 models need to keep each deflector with their corresponding support block. *Tip: Removing the airbox will make the driver side deflector easier to remove, however it is unnecessary.*



38. Use a 13mm socket to remove the passenger side, upper inside bumper bolt then replace it with the M8 x 30mm long hex flange bolt and M8 washer included in hardware bag #5.



39. Remove the two bolts and two nuts holding the AC condenser in place. Be careful as you remove the fourth screw as the condenser will be loose and only held in place by the AC hoses and surrounding components.

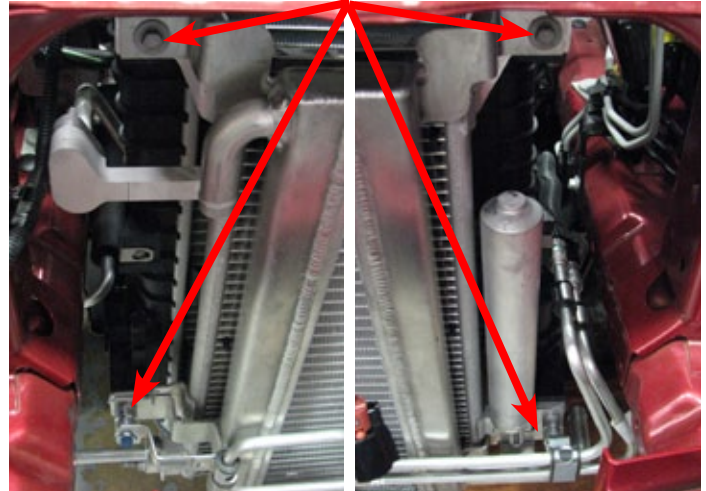

40. Install the heat exchanger in front of the condenser so that the downward bent tube is on the passenger side, then raise the heat exchanger and condenser together and secure them using the stock fasteners.

41. Mount the water pump onto the water pump bracket by sliding the bent edge of the strap into the notch on the bracket. Use a 12mm socket to tighten the supplied bolt on the other end of the strap. Orient the pump so the outlet will point up and back towards the intercooler inlet. The water pump intake will point towards the passenger side fender.

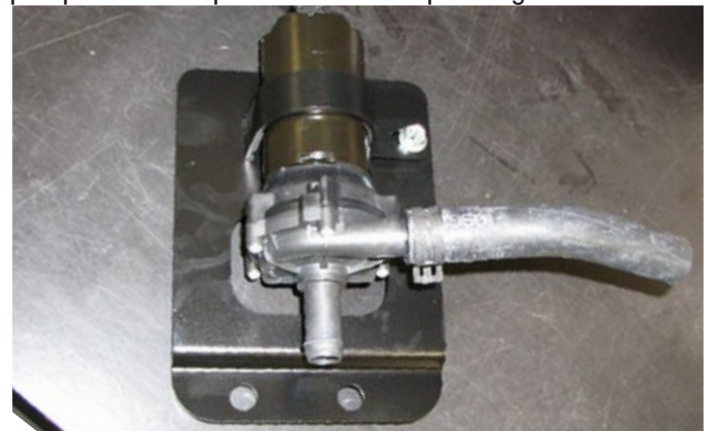

42. Fit the short molded hose onto the outlet of the water pump and secure it with a hose clamp.



Edelbrock Supercharger System 2011-2013 Ford Mustang 5.0L

Installation Instructions

43. Slide an extra clamp onto the outlet hose, then install the water pump and bracket by sliding it over the two inside bumper bolts on the passenger side. Slide the outlet hose onto the inlet tube of the heat exchanger then secure it by sliding the hose clamp up and into place.

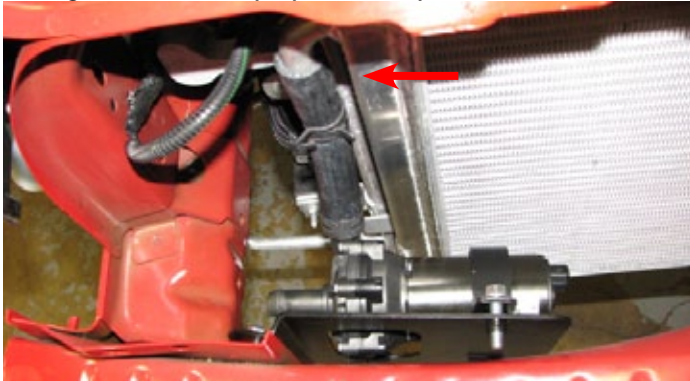

44. Using a hole-saw, cut a 1.125" diameter hole in the passenger side plastic deflector in the location shown. Route the long molded hose under the fuse box to the intake of the water pump. Then carefully pass the hose through the hole.



45. Place a hose clamp onto the water pump hose and connect it to the water pump. Secure pump bracket using the M8 flange nuts in bag #5 to the two studs protruding behind the passenger side crash beam using a 13mm deep socket.



46. Install the long 3/4" hose onto the driver side barb of the heat exchanger and secure it with a clamp. Route the rest of the hose around the A/C hard line, avoiding close proximity to the exhaust manifold and power steering pump, and up between the engine and driver side fender.



47. Reinstall the driver side radiator shroud along with the airbox (if it was previously removed).

48. Use a 10mm socket to loosen and remove the two bolts supporting the coolant reservoir. It is not necessary to fully remove it, just loosened so that it can be shifted.



49. Use a 15mm socket to loosen the tensioner and remove the stock belt. Use a 13mm socket to remove the stock tensioner from the front engine cover.

50. Disconnect the upper radiator hose from the radiator.



Edelbrock Supercharger System 2011-2013 Ford Mustang 5.0L

Installation Instructions

51. Remove the engine cover bolt on the lower left using a 10mm socket. Use a 90° drill and the supplied drill bit, drill out the three (3) holes on the front engine cover located on the passenger side. **(NOTE: The left hole on some vehicles will already be drilled and tapped by the factory. Please inspect your front cover and avoid drilling this hole if already tapped.)** The hole on the left and the hole on the top should be drilled .72" deep. The hole on the right should be drilled 1.01" deep. All holes should be tapped to M8 x 1.25 with the supplied tap.

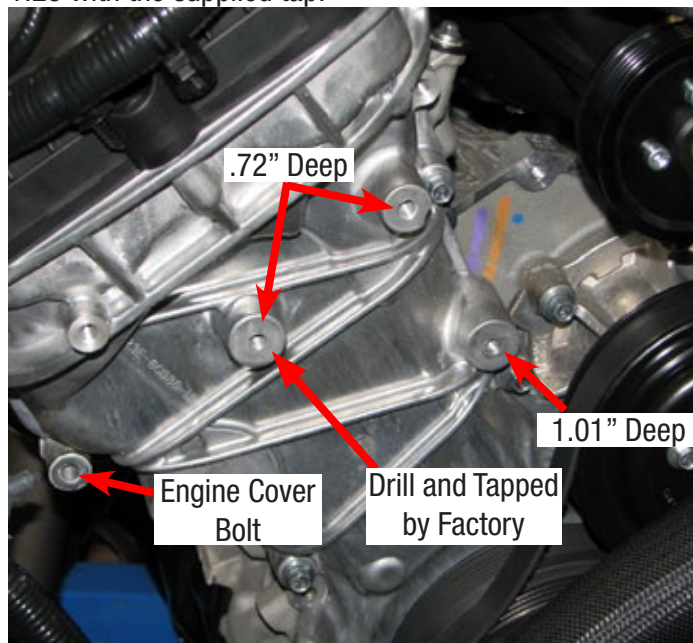

52. Secure the new tensioner bracket to the bosses that were just drilled and tapped with bolts supplied in Bag #3. **(NOTE: When installing the countersunk bolt, place the .045" thick brass spacer between the bracket and the front engine cover if the hole was drilled and tapped by the factory.)** Apply blue Loctite to threads and loosely install the following four (4) bolts, starting with the M8 x 25mm countersunk bolt into the countersunk feature of the bracket located on the left side of the bracket. Install the M8 x 20mm bolt through the hole at the top, then install the M8 x 40mm bolt through the hole below and to the right. Use an M8 x 90mm bolt in the counter bore feature at the lower left section of the bracket. Proceed by tightening the countersunk bolt first and then tightening the remaining surrounding bolts.

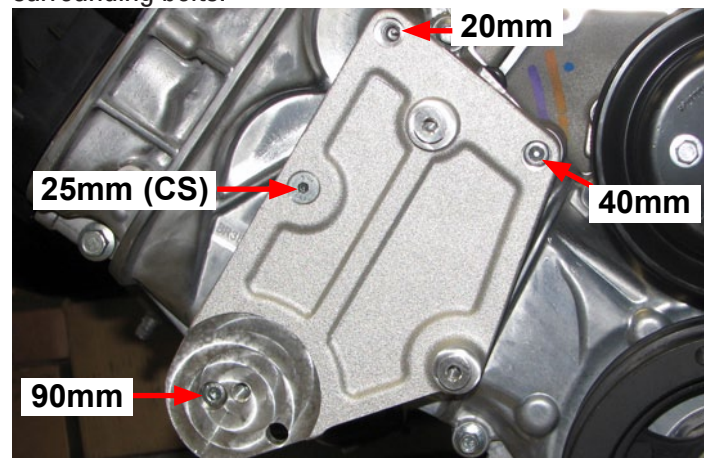

53. Secure the idler bracket by installing the 110mm bolt through the ear of the alternator, the 90mm bolt into the top, front cover hole and the 45mm bolt through the lower hole that was used to secure the stock tensioner.

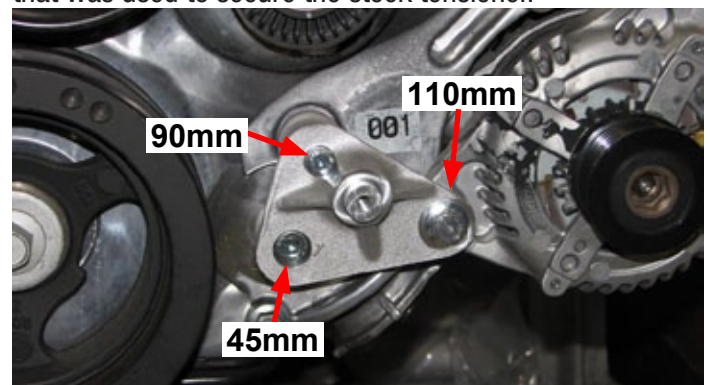



Edelbrock Supercharger System 2011-2013 Ford Mustang 5.0L

Installation Instructions

54. Remove the bolt that secures the air conditioning hard line bracket (if present) and gently bend the AC line until it can be attached using the bracket and M6 x 16mm bolt supplied in Bag #3. **NOTE: On manual transmission vehicles there will be two hard AC lines, on automatics there will only be one.**

55. Install the tensioner with a 65mm bolt and the three idler pulleys with M8 x 20mm bolts and washers, all supplied in Bag #3. Leave the tensioner bolt loose until the belt is installed. The smaller 65mm pulley should be installed on the uppermost boss on the tensioner bracket.

56. Locate the small fitting extending vertically from the thermostat housing. Use an 10mm socket to gently bend this fitting roughly 5° outboard so that it will clear the supercharger manifold.



57. Remove the coil covers from the cylinder heads, then remove the ignition coils to access the spark plugs. Remove the plugs with a 5/8" spark plug socket and gap them to .034". Reinstall the plugs and torque them to 9 ft-lbs., then reinstall the coils and coil covers. Be sure to install the plugs and coils in the same spot they came off.

58. Install the stock O-ring seals into the grooves on the intake flanges of the supercharger. Be sure to line up the tab on the O-rings with the notches provided.

59. Be sure that the engine bay is clean and free of debris, then remove the masking tape used to protect the intake ports from contamination.

60. With the help of an assistant or a cherry picker, carefully lower the supercharger assembly onto the cylinder heads. Be especially careful not to pinch any wires between the supercharger and the cylinder heads.

61. Ensure correct alignment of the supercharger by sighting through the fuel injector bores and adjusting the manifold until it is centered left to right as well as front to back on the engine block.

62. Use a 10mm socket to install the intake bolts supplied in hardware bag #1 then torque them to 8 ft-lbs in the sequence shown below.

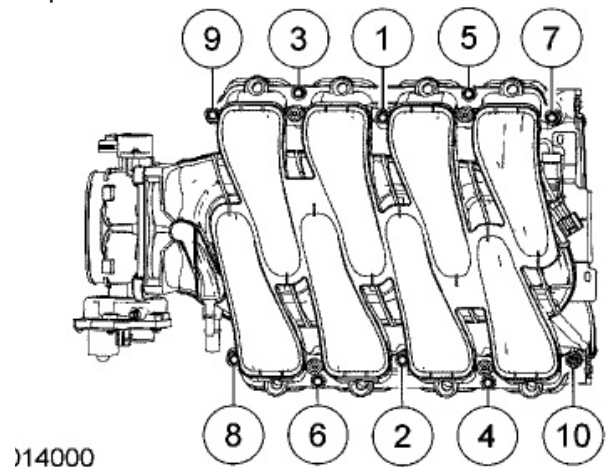

14000

63. Install the black anodized plugs supplied with the fuel rails on both ends of the passenger side rail and in the rear provision of the driver side rail.

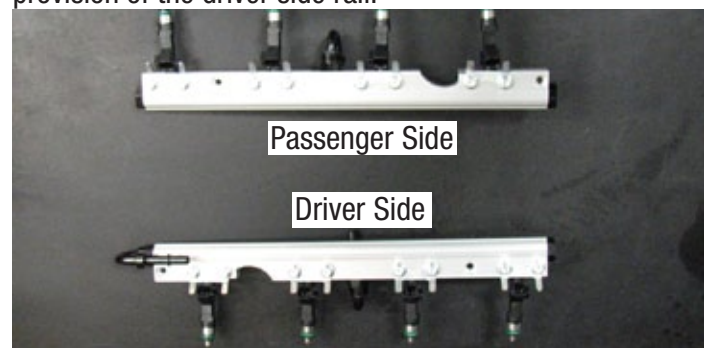

64. Install the supplied black anodized 180° fittings into the front provision of the driver side rail and in the bottom, center provision of both rails so that they extend inward toward the supercharger.



Edelbrock Supercharger System 2011-2013 Ford Mustang 5.0L

Installation Instructions

65. Clip the supplied fuel crossover hose onto the 180° shaped fittings installed in the center of each rail.

66. Cover the injector bores with tape to prevent debris from entering the bores. Trim the two (2) back valve cover tabs on the passenger side and the two (2) front tabs on the driver side. Then carefully blow out any debris with shop air and remove the tape.

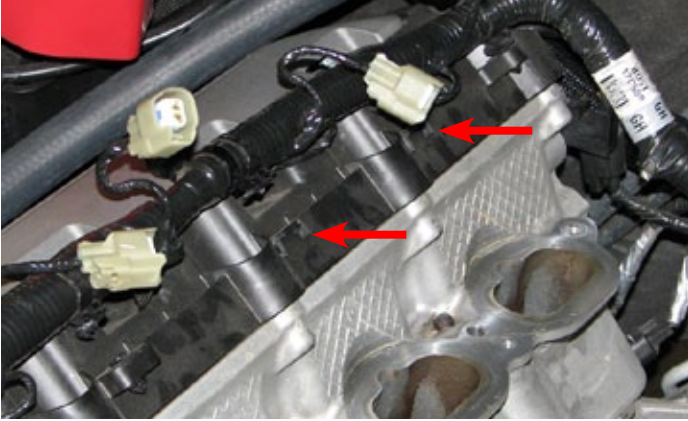

67. Apply O-ring lube to both ends of the supplied fuel injectors, then install them into the supplied fuel rails, oriented so that the electrical connectors will face away from the supercharger.

68. Install the injector alignment brackets onto the fuel rails using the bolts supplied in Bag #1.

69. Mark the actuator rod where it goes into the actuator body so that it can be reinstalled in the same position, then unbolt the actuator from the manifold.



70. Lower the fuel rail assembly onto the supercharger and line up the fuel injectors with their provisions on the manifold. Push down on the rails gently until the fuel injectors are fully seated then install the four M6 x 30mm bolts supplied in Bag #1 to secure the rails.

71. Line the actuator rod up with the mark previously made, then reinstall the actuator bolts.

72. Connect each of the fuel injectors to the appropriate terminal on the main engine wiring harness.

73. Install the supplied belt according to the routing diagram shown below, then fully tighten the tensioner bolt. Use a 3/8" drive breaker bar to rotate the tensioner enough to install the belt on the tensioner pulley.

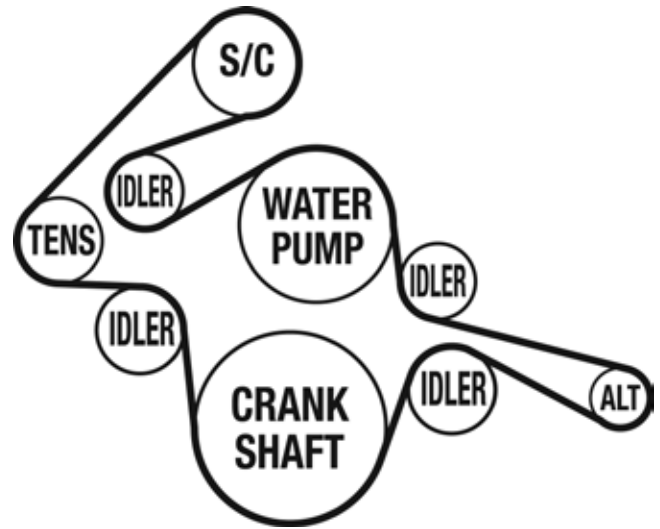

74. Clip the stock fuel inlet line into the 180° fitting on the front end of the driver side fuel rail.

NOTE: Steps 75-76 apply to vehicles equipped with a manual transmission only. Disregard otherwise.

75. Remove the hose clamp that secures the bulk of the brake booster hose assembly to the 90° plastic fitting then pull the hose off the fitting.

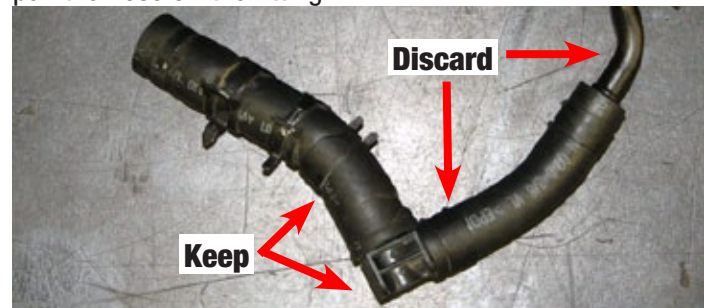



Edelbrock Supercharger System 2011-2013 Ford Mustang 5.0L

Installation Instructions

76. Attach the supplied brake booster hose onto the 90° plastic fitting previously attached to the stock brake booster line. Attach the short length of 1/2" hose from the other end of the fitting, to the nipple on the driver side of the air inlet then secure it with the stock clamp.

NOTE: Steps 77-78 apply to vehicles equipped with automatic transmissions only. Disregard otherwise.

77. Remove the stock brake hose assembly from the brake booster. Removing the protective foam from the brake aspirator as well as all the factory hoses.



78. Install the short aspirator to manifold hose onto the aspirator on the end next to the capped barb and attach to .5" fitting on manifold. Then attach the 3/8" brake booster to aspirator hose and route it along the driver side cylinder head, then attach it to the brake booster securing it with a clamp.

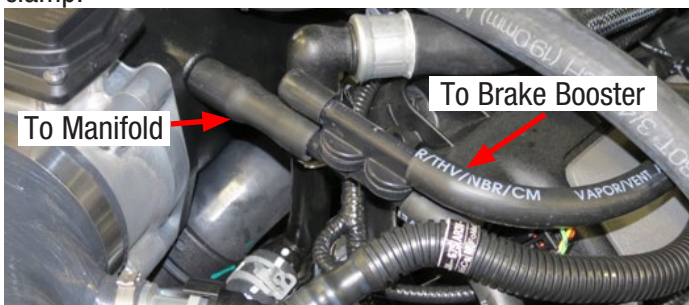

79. Reinstall the passenger side coolant nipple and attach the stock heater hoses to the fittings on the heads.



80. Install the stock EVAP solenoid on the provision at the top of the nose inlet using the stock bolts and O-ring.



81. Install the stock throttle body on the nose inlet using the stock O-ring seal and bolts.



82. Use a razor blade or Exacto knife to carefully cut the end of the stock EVAP hose that attaches to the solenoid and remove the fitting. Use caution not to damage the fitting in the process. Install this fitting into the supplied EVAP solenoid hose.



83. Install the supplied EVAP hose on the EVAP solenoid and route it back along the passenger side fuel rail, around the back of the engine and down to attach it to the EVAP hard line located below the brake booster.





Edelbrock Supercharger System 2011-2013 Ford Mustang 5.0L

Installation Instructions

84. Install the stock driver side PCV hose onto the passenger side PCV fitting and attach it to the passenger side of the supercharger manifold.

85. Using a 10mm socket, mount the supplied water pump wiring harness relay on the front of the fuse box housing next to the ECU using the existing bolt.



86. Route the ground wire to the inboard grounding bolt.



87. Use a 10mm socket to attach the power wire to the power terminal on the fuse box.



88. Route the water pump electrical connector below the fuse box and around the washer fluid reservoir and plug it into the intercooler water pump.

89. Use a 10mm wrench to remove one nut and two bolts securing the fuse box to the vehicle. Lift the inboard side of the fuse box off of the grounding stud, then set it aside.

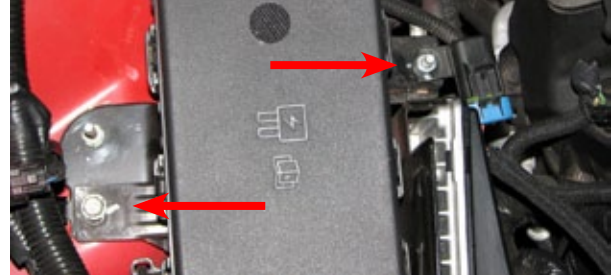

90. Remove the 10mm ground strap from the passenger side strut tower bracket and pull out the harness body pin. Route the strap to the ground stud on the inboard side of the fuse box and secure it with the stock bolt. Then re-install the fuse box with the original nut.



91. Use a .250" drill bit or step-drill bit to enlarge the hole on the fuse holder. Attach the fuse holder onto the same ground stud on top of the original nut. Secure the fuse holder using the supplied nut in bag #7.

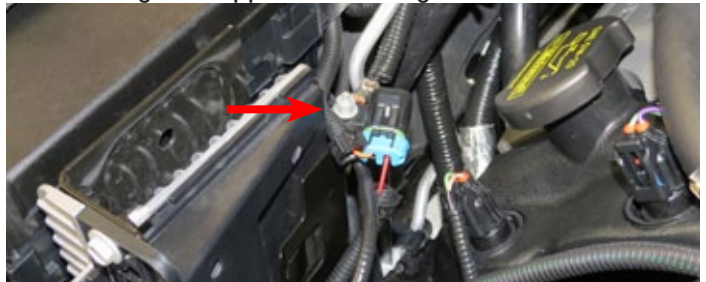

92. Attach the long molded hose to the bottom barb of the recovery tank and secure it with a clamp.

93. Attach the stock EVAP solenoid connector on the main engine wiring harness to the matching connector on the water pump harness then attach the water pump harness connector to the EVAP solenoid.



Edelbrock Supercharger System 2011-2013 Ford Mustang 5.0L

Installation Instructions

94. Remove the two inner strut tower nuts from the passenger side strut tower.

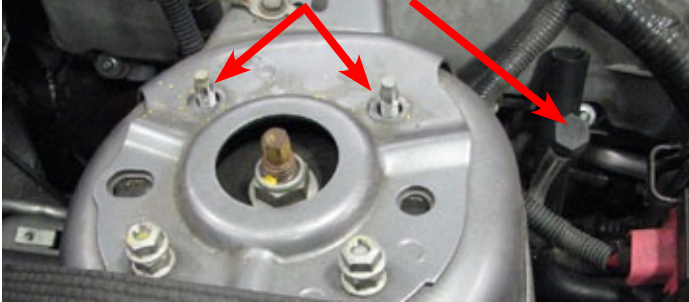

95. Hang the recovery tank bracket from the exposed strut tower studs. Bend the A/C service port slightly so that it is positioned between the recovery tank and the passenger side fender.



96. Install the short straight hose from the recovery tank to the passenger side intercooler fitting and secure both ends with the supplied hose clamps.

97. Install and torque the strut tower nuts to 26 ft/lbs.

98. Install the throttle body elbow onto the throttle body and secure it with the provided hose clamps. The flexible elbow should be oriented so that it can be easily mated to the air cleaner cover outlet tube. Install the supplied driver side PCV to the driver side valve cover and the intake tube.

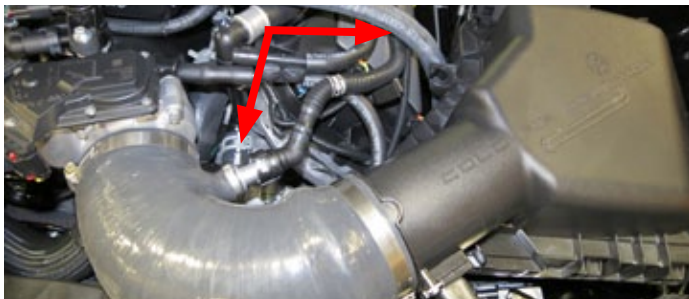

NOTE: Step 99 applies to Automatic vehicles only. Disregard otherwise.

99. Install the aspirator to intake hose with the 90° quick connector fitting onto the intake elbow and then to the brake aspirator. Trim hose as needed.

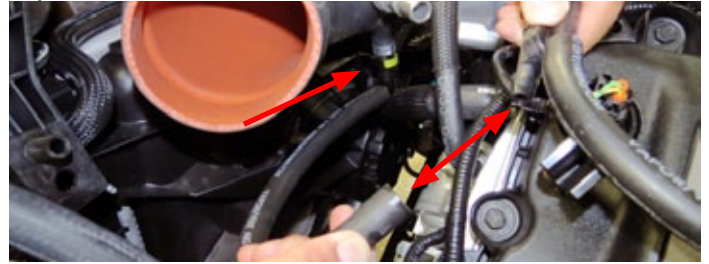

100. Plug the MAF/Temp wiring harness into the Temp sensor located at the back of the manifold on the passenger side. Route the harness from the passenger side to the driver side behind the manifold. Then route its remaining length along the driver side heater hose.

101. Separate the MAF harness connector from the MAF sensor located at the outlet of the airbox. Connect the engine harness to the connector on the MAF/Temp harness then attach the MAF/Temp harness to the MAF Sensor. Reattach the harness to the tab on the airbox.

102. Connect the heat exchanger to intercooler hose to the fitting on the driver side of the manifold and secure it with a clamp.

103. Reinstall the grill support (if equipped) and the foam bumper insulator. .

104. Reconnect the fog lights and indicators, then replace the fascia onto the front of the car.

105. Reinstall the screws and push in rivets that secure the inner fender wells, then reinstall the top front fascia bolts.

106. Replace the lower splash shield and secure it with the stock fasteners. The vehicle can now be lowered.

107. Verify that the coolant petcock is closed, then refill the coolant system.



Edelbrock Supercharger System 2011-2013 Ford Mustang 5.0L

Installation Instructions

108. Fill the intercooler system with a 50/50 blend of water and coolant poured into the recovery tank. Fill the tank until the water level is roughly 1" from the top of the threaded neck.
109. Turn the ignition key to the 'ON' position.
110. Verify that water is flowing briskly through the recovery tank, then install the cap.

If you have yet to flash your ECU, then proceed with steps 111 - 124, otherwise disregard them.

111. It is recommended that you check the Edelbrock website at: (http://www.edelbrock.com/automotive_new/mc/superchargers/fuel_injected_soft-tech.shtml) to confirm that you have the latest calibration. Once you have found the latest tune on the site, power on the programmer, press the left arrow and select the Device Info option. Scroll down to "Tune Version" and compare that number to the one on the site. If they are different, download the new calibration with the supplied USB cable.
112. Put the car into Acc mode, but don't start the vehicle
113. Connect the supplied PCM cable on the handheld programmer to the OBD-II connector located below the steering wheel, and to the left of your knee..
114. Use directional pad to highlight Program Vehicle option and press Select button.



115. Use directional pad to highlight Pre-programmed Tune option and press Select button.
116. Read disclaimer then press Select to continue.
117. Verify ignition is in the 'Key On' position but that the engine is not running then press Select.

118. Use directional pad to highlight your vehicle and transmission combination then press Select.
119. Use directional pad to highlight Begin Program then press Select.
120. Depending on your specific drivetrain configuration, several separate operations may take place during this step. Completion of each operation will cause the progress bar to reset to zero.

DO NOT unplug the programmer until prompted.

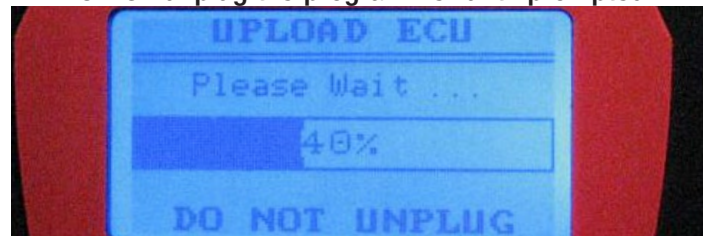

121. Turn the vehicle off when prompted to do so by the handheld programmer.
 122. Read parting message from programmer then press Select to continue.
 123. Unplug the programmer cable from the OBD-II port.
-
124. If you have access to a diagnostic scan tool, run a 'Key On, Engine Off' test to verify that all connectors are properly installed, otherwise move on to the next step.
 125. Start the vehicle and verify a smooth idle. If you are using a diagnostic scan tool, run a 'Key On, Engine Run' test.
 126. Carefully inspect the fuel rail and fuel hose fittings for any leaks. Shut off the engine immediately and make repairs as necessary before continuing if any leaks are detected.
 127. Check all fluid levels before operating vehicle.
- Congratulations on the installation of your new Edelbrock E-Force Supercharger System. If you have any questions, please call our Technical Support hotline and one of our technicians will be happy to assist you.



Edelbrock Supercharger System 2011-2013 Ford Mustang 5.0L

Installation Instructions

Email Edelbrock Your Stock Vehicle Calibration

In the rare occurrence that you encounter an error message that reads “Calibration not supported” during the test flash procedure on page 8, you will need to email Edelbrock your stock vehicle calibration to Calibration@edelbrock.com. Otherwise, disregard this step.

- Begin by downloading the SCT device updater software to your computer; it can be downloaded from: <http://www.sctflash.com/software/SCTDeviceUpdater.exe>
- Put the car into Acc mode but do not start it.
- Connect the supplied PCM cable from the tuner to the OBD-II connector.
- Select PROGRAM VEHICLE, arrow over to UPLOAD STOCK, press SELECT and follow the prompts on the screen.
- If the upload fails, you will be asked to AUTO DETECT, press SELECT and follow the prompts on the screen. If the auto detect fail, then please contact Edelbrock Tech support @ 800-416-8628
- Once the stock calibration has loaded, disconnect the programmer from the OBD-II connector and connect it to your PC using the supplied USB cable.
- Open the SCT software and select the button on the lower left hand side that reads GET STOCK FILE FROM DEVICE. Follow the instructions on the screen.
- Once the download is complete email your stock calibration to Calibration@edelbrock.com, or call 1-800-416-8628 and our tech support staff will assist you in e-mailing the file.
NOTE: The subject line of your email should be “file update needed”, The file will automatically be labeled using your VIN # followed by “.sul “ (XXXXXXXXXXXXX.sul)
- Once we have this file we can update the tune to work with your application, then we will e- mail you the custom tune which you may use until the release version is available. (This process can usually be completed within 1 to 2 business days)
- Download the new tune to the programmer using the directions received with the custom tune.
- Re-try the test flash procedure using the custom tune.