



FORD PERFORMANCE

Instruction Sheet

M-6017-504V 5.0L Controls Pack

NO PART OF THIS DOCUMENT MAY BE REPRODUCED WITHOUT PRIOR AGREEMENT AND WRITTEN PERMISSION OF FORD RACING PERFORMANCE PARTS

Please visit www.fordracingparts.com for the most current instruction and warranty information.

PLEASE READ ALL OF THE FOLLOWING INSTRUCTIONS CAREFULLY PRIOR TO INSTALLATION. AT ANY TIME YOU DO NOT UNDERSTAND THE INSTRUCTIONS, PLEASE CALL THE FORD PERFORMANCE TECHLINE AT 1-800-367-3788

5.0L Controls Pack Installation Manual



Factory Ford shop manuals are available from Helm Publications, 1-800-782-4356



FORD PERFORMANCE

Instruction Sheet

M-6017-504V 5.0L Controls Pack

NO PART OF THIS DOCUMENT MAY BE REPRODUCED WITHOUT PRIOR AGREEMENT AND WRITTEN PERMISSION OF FORD RACING PERFORMANCE PARTS

TABLE OF CONTENTS

Section	Topic	Page
1.0	Introduction	2
2.0	Overview	2
3.0	Included Components	2-7
4.0	Pre-Installation of Harness and Parts	7-11
5.0	Controls Pack Harness Installation Instructions	11-13
6.0	16-way I/P Pigtail Connection Details	14-16
7.0	Ford Performance Power Distribution Box Installation	16
8.0	Fuel System	16-18
9.0	Initial Start-Up	18
10.0	Wire Usage Schematics	18-20
11.0	Fuses & Relays	21
12.0	Connector Faces	21-22

1.0 Introduction

This kit was developed by Ford Performance in order to allow performance enthusiasts the ability to install our 5.0L 4V TiVCT NA Crate Engine (Ford Performance P/N: M-6007-M50A) into the application of their choice. The system supports use of a manual transmission only.

Note: Cruise control is not available with this system

2.0 Overview

This booklet provides a step by step guide for the preparation and installation of the controls pack. Please read the instructions thoroughly before starting the installation. If you have any questions, contact Ford Performance Technical Support at (800) 367-3788.

3.0 Included Components

3.1 Powertrain Control Module (PCM) – FR3Z-12A650-EGC

- The PCM is the central processing unit for engine operation. Input data/engine operation feedback is provided from each of the engine’s sensors connected to the PCM via wiring leads. This input data is used to perform calculations that in turn adjust fuel quantity and spark timing according to varying driver demand (ie – accelerator pedal input).

Factory Ford shop manuals are available from Helm Publications, 1-800-782-4356



FORD PERFORMANCE

Instruction Sheet

M-6017-504V 5.0L Controls Pack

NO PART OF THIS DOCUMENT MAY BE REPRODUCED WITHOUT PRIOR AGREEMENT AND WRITTEN PERMISSION OF FORD RACING PERFORMANCE PARTS

- The wiring that plugs into the PCM is integral to the wiring harness that was included with your 5.0L crate engine, the length of these wiring leads dictate that mounting location be in close proximity to the engine itself.
- The PCM in this Controls Pack has a custom software and calibration dataset which were specifically modified/developed by Ford Performance engineers to provide peak performance and reliability with the 5.0L 4V TiVCT NA Crate Engine (Ford Performance P/N: M-6007-M50A)



PCM Calibration Application Notes:

- The calibration provided in this PCM will NOT work with the 'Returnless' fuel system as used on factory Mustang vehicles. Use of a return style fuel system is required. Refer to Section 8 of this manual for more information on fuel system requirements for this PCM.
- The Air Filter Assembly with Integral Mass Air Flow Sensor included with this kit must be used to achieve acceptable engine performance. If air filter assembly provided is not used, calibration will be required. Refer to Section 3.7 for more information about Air Inlet System requirements.
- **Premium Fuel Only (91 Octane or higher).**

NOTE: Due to the fuel system requirement described above, installation of this PCM in ANY Production Mustang vehicle will result in a no-start condition!

3.2 Accelerator Pedal Position Sensor (APPS) – CR3Z-9F836-C

- The accelerator pedal assembly includes a pair of integrated pedal position sensors (APPS1/APPS2). This pedal has electrical properties designed specifically for correct interface with PCM: FR3Z-12A650-EGC and is required for proper engine operation.



Factory Ford shop manuals are available from Helm Publications, 1-800-782-4356



FORD PERFORMANCE

Instruction Sheet

M-6017-504V 5.0L Controls Pack

NO PART OF THIS DOCUMENT MAY BE REPRODUCED WITHOUT PRIOR AGREEMENT AND WRITTEN PERMISSION OF FORD RACING PERFORMANCE PARTS

3.3 Clutch Pedal Position Switches: Bottom Travel (CBT) - 6G9Z-11A152-A (Gray Plunger) Top Travel (CTT) - 4M5Z-11A152-A (Black Plunger)



(CBT)



(CTT)

- The switches translate the clutch pedal position to the PCM. The bottom travel switch also acts as a starter safety interlock. The starter motor will not energize until the clutch has been fully depressed.
- CBT switch is Normally Open (IE – Clutch Pedal NOT fully depressed); Closed with Clutch Pedal fully depressed
- CTT switch is Normally Open (IE – With Foot off Clutch Pedal); Closed Otherwise
- Clutch pedal assembly P/N: BV61-7B633-AA is available through an Authorized Ford Parts dealer. Includes a clutch pedal and mounting bracket with provisions to hold both the Top and Bottom of Travel switches in the appropriate locations.

WARNING: DO NOT BYPASS THE STARTER INTERLOCK. DOING SO CREATES A HAZARD TO THOSE IN AND AROUND THE VEHICLE AS THE STARTER CAN OPERATE WITH THE TRANSMISSION IN GEAR AND THE CLUTCH PEDAL ENGAGED.

3.4 Universal Exhaust Gas Oxygen Sensor (UEGO) – FL3Z-9G444-A

- Two UEGO sensors provide wide range feedback to the PCM for closed loop air fuel ratio control by measuring the quantity of oxygen present in exhaust leaving the combustion chamber.
- Each UEGO is supplied with a light coating of anti-seize lubricant on its threads. Please use caution when installing as this lubricant will damage the sensor element, so make sure no lubricant comes in contact with the sensor element (tip).
- Tighten to 48 Nm (35 lb-ft).
- **NOTE:** Do not splice, lengthen or otherwise modify the UEGO wiring. Doing so will adversely affect the sensor performance & reliability of the signal.



Factory Ford shop manuals are available from Helm Publications, 1-800-782-4356



FORD PERFORMANCE

Instruction Sheet

M-6017-504V 5.0L Controls Pack

NO PART OF THIS DOCUMENT MAY BE REPRODUCED WITHOUT PRIOR AGREEMENT AND WRITTEN PERMISSION OF FORD RACING PERFORMANCE PARTS

The engine harness and controls package M-6017-504V is designed to operate with the UEGO sensors in the 2015 Mustang GT stock locations. Moving the UEGO sensors to alternate locations can result in the need to recalibrate the PCM.

Here are some tips if sensors have to be relocated:

The best option is to locate the sensor so it is sampling from all 4 cylinders and at a distance that does not require modification of the UEGO harness.

NOTE: Modification of the UEGO harness can affect function of UEGO sensor.

If your header design will not allow you to sample all 4 cylinders without UEGO harness modifications, a better alternative is locating the UEGO sensor to sample from a single cylinder. The cylinders that have (on average) the closest A/F ratio to the bank average are cylinder #4 (on bank 1) and cylinder #7 (on bank 2). If that's not possible due to packaging constraints, the next best choices are cylinder #3 (on bank 1) and cylinder #8 (on bank 2). Calibration required!

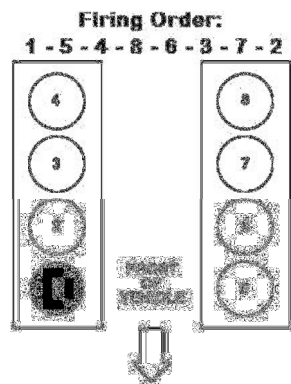

3.5 B + to FPPDB Cable Assembly

- Provides B+ from Battery "+" Post to in-line fuse and then to the Ford Performance Power Distribution Box (FPPDB)
- It is extremely important that the ground eyelet connection (discussed later) is attached to a solid grounding location

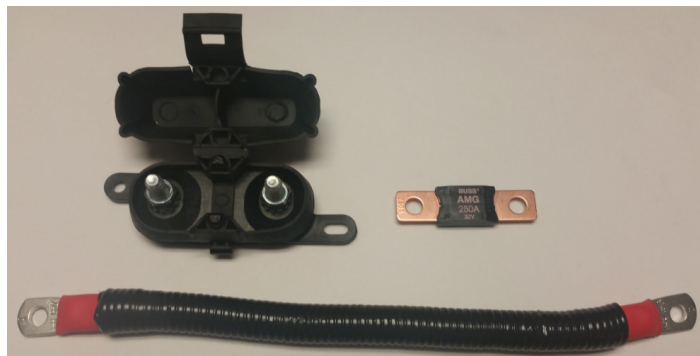

Factory Ford shop manuals are available from Helm Publications, 1-800-782-4356



FORD PERFORMANCE

Instruction Sheet

M-6017-504V 5.0L Controls Pack

NO PART OF THIS DOCUMENT MAY BE REPRODUCED WITHOUT PRIOR AGREEMENT AND WRITTEN PERMISSION OF FORD RACING PERFORMANCE PARTS

3.6 Plastic Bag of Assorted Items

- Zip-ties
- 4 AWG Jumper Cable
- Buss 250A In-line Fuse
- Malfunction Indicator Light
- Small diameter heat shrink (red)
- Large diameter heat shrink (black)
- Large diameter eyelet terminal
- Small diameter eyelet terminal



3.7 Air Cleaner Assembly with Integral Mass Air Flow Sensor – FR3Z-9600-B, FR3Z-9B659-C, FR3Z-9F763-B



IMPORTANT NOTE: The calibration of the PCM you have received requires use of this air box/MAF sensor system exactly as received. Any changes to the air inlet system will result in changes to how the air entering the engine is measured and will require modification to the PCM's calibration.

Factory Ford shop manuals are available from Helm Publications, 1-800-782-4356



FORD PERFORMANCE

Instruction Sheet

M-6017-504V 5.0L Controls Pack

NO PART OF THIS DOCUMENT MAY BE REPRODUCED WITHOUT PRIOR AGREEMENT AND WRITTEN PERMISSION OF FORD RACING PERFORMANCE PARTS

Ford Performance recognizes that it may not be practical to package this Air Box/MAF sensor system in some vehicle applications. The recommendations listed below are intended to serve as guidelines for designing an air inlet system that will provide good control system performance once the control system calibration has been modified to work with the new Air Inlet System:

1. **Flow Profile:** the MAF sensor should be located on a straight section of zip tube where the flow profile is generally uniform. If the sensor cannot be located on a straight section put the sensor on the outside radius of the inlet so the sensor is located in the higher flow velocity area.
2. **Flow Area:** Keep the cross sectional area of the MAF sensor tube as close as possible to the cross sectional area of the original induction system.
3. **Flow quality:** minimize flow direction changes and maintain smooth tubing to minimize air flow disturbances and turbulence.
4. **Flow pulsation:** install sensor at least 6 to 8 inches upstream of the throttle body.
5. **Transient performance:** installing the sensor too far upstream of the throttle body (>24 inches) will result in transient lean/rich spikes due to the additional amount of time required for the measured air flow to travel from the MAF sensor to the intake manifold.
6. **MAF sensor contamination:** A) install sensor in upper half of cross sectional area to minimize possibility of condensation coming in contact with the MAF sensor element. In other words, if a clock is superimposed on a cross section of the zip tube, the sensor should be installed somewhere equal to or above the 9:00 and 3:00 positions. Most OEM applications have the sensor located at the 9:00 or 3:00 location. B) Sensor must be installed downstream of air filter and upstream of crank case ventilation inlet. Ideally, sensor should be located 3 diameters upstream of the crank case ventilation inlet.

3.8 Controls Pack Wiring Assembly – CM-14A006-A504VA

- Connects to vehicle battery and inline connector on engine harness
- Contains Ford Performance Power Distribution Box (FPPDB) and High Power 250A inline fuse
- Electrical connections to Accelerator Pedal (APPS) and Clutch Switches (CBT/CTT)
- Wire leads for Ignition Switch & Starter,
- Data Link Connector for reading Diagnostic Trouble Codes (DTCs)
- Check Engine/Malfunction Indicator Lamp (MIL) for visual indication of engine control system fault code presence
- MIL will stay illuminated when the ignition is ON and the engine is NOT running; therefore this condition does not indicate a system fault; Not all DTCs will cause the MIL to illuminate
- MIL on stock instrument panel will not work—only the MIL included in this kit will illuminate if a fault exists.

4.0 Pre-Installation of Harness and Parts

4.1 Planning

The following is a list of key factors to consider before any installation takes place:

- PCM mounting location is limited by the lengths of the (2) corresponding leads into which the PCM is connected. These leads are an integral part of the CRATE ENGINE HARNESS (not included with Controls Pack)
- Inline Fuse Holder must be mounted within 12” of the vehicle battery “+” post when using the supplied 4AWG Jumper Cable

Factory Ford shop manuals are available from Helm Publications, 1-800-782-4356



FORD PERFORMANCE

Instruction Sheet

M-6017-504V 5.0L Controls Pack

NO PART OF THIS DOCUMENT MAY BE REPRODUCED WITHOUT PRIOR AGREEMENT AND WRITTEN PERMISSION OF FORD RACING PERFORMANCE PARTS

- Ford Performance Power Distribution Box must be mounted within 60" of the vehicle battery as dictated by the B+/Ground Lead Lengths of the controls pack wiring harness
- Lay out the harness and components first in order to ensure that the wiring leads will reach everywhere you intend them to. This is a good reality check before you drill any holes or mount any components!

4.2 Connector ID

Item	Connector #	Description	Item	Connector #	Description
A	-	UEGO	O	-	Blunt Cut Cooling Fan Lead
B	C500	PCM GND/B+ MAIN	P	C400	2-way ICP for optional supercharger
C	-	FPPDB	Q	C102A	Alternator
D	-	Firewall Grommet	R	C128	MAF
E	GD200	Ground	S	C160B	16-way I/P Pigtail Connector
F	C160A	Inline to I/P Pigtail Connector	T	C175B	103-way Cowl Pocket Connector
G	C2040	APPS	U	C146	Inline to 12C508 (Engine Harness)
H	C257	Clutch Bottom of Travel	V	-	Ground: (-) Terminal of Battery
I	C277	Clutch Top of Travel	W	-	In-line Fuse Holder Terminal (FPPDB)
J	GD100	Ground	X	C500	Fuse and Relay Power and Ground
K	C251	Data Link Connector/OBD2	Y	-	FPPDB Power Terminal
L	C100	A/C Clutch Field	Z1	-	In-line Fuse Holder Terminal (Battery)
M	C1260	A/C Pressure Switch	Z2	-	Power: (+) Terminal of Battery
N	-	Starter Lead	-	-	-

Table 1 – Summary of ControlsPack Connectors

Factory Ford shop manuals are available from Helm Publications, 1-800-782-4356



FORD **PERFORMANCE**

Instruction Sheet

M-6017-504V 5.0L Controls Pack

NO PART OF THIS DOCUMENT MAY BE REPRODUCED WITHOUT PRIOR AGREEMENT AND WRITTEN PERMISSION OF FORD RACING PERFORMANCE PARTS

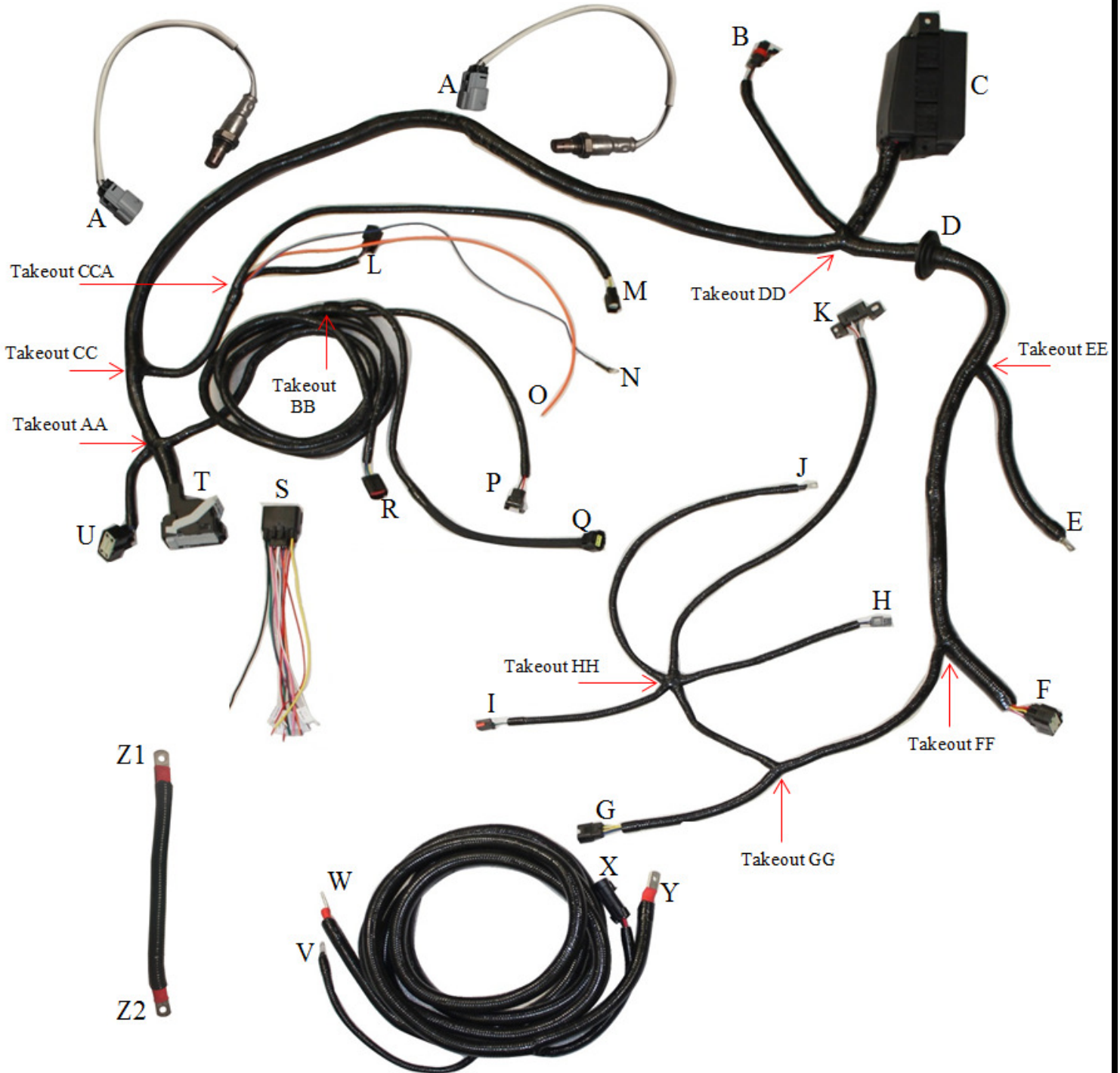

Figure 1 - Controls Pack Wiring Harness Components

Factory Ford shop manuals are available from Helm Publications, 1-800-782-4356



FORD PERFORMANCE

Instruction Sheet

M-6017-504V 5.0L Controls Pack

NO PART OF THIS DOCUMENT MAY BE REPRODUCED WITHOUT PRIOR AGREEMENT AND WRITTEN PERMISSION OF FORD RACING PERFORMANCE PARTS

4.3 Tools Required

- Wire Cutter/Stripping Tool
- Crimper
- Digital Volt/Ohm Meter
- Solder Gun / Solder
- Center Punch
- Cordless Drill / Drill bits / Hole saw / Screwdriver bits

4.4 Cap off the Unused Supercharger Intercooler Connector if Applicable

If your vehicle is not supercharged, locate the 2-way ICP (Item P, Connector C400, Controls Pack Wiring Harness) and cut the wires leading to the connector and tape each wire, or place shrink tube over it, INDIVIDUALLY. This is very important in order to ensure that you do not inadvertently short a hot and ground lead together, causing damage to your PCM and/or other sensitive electronics.

4.5 Engine Harness Routing

Rear View of Engine:

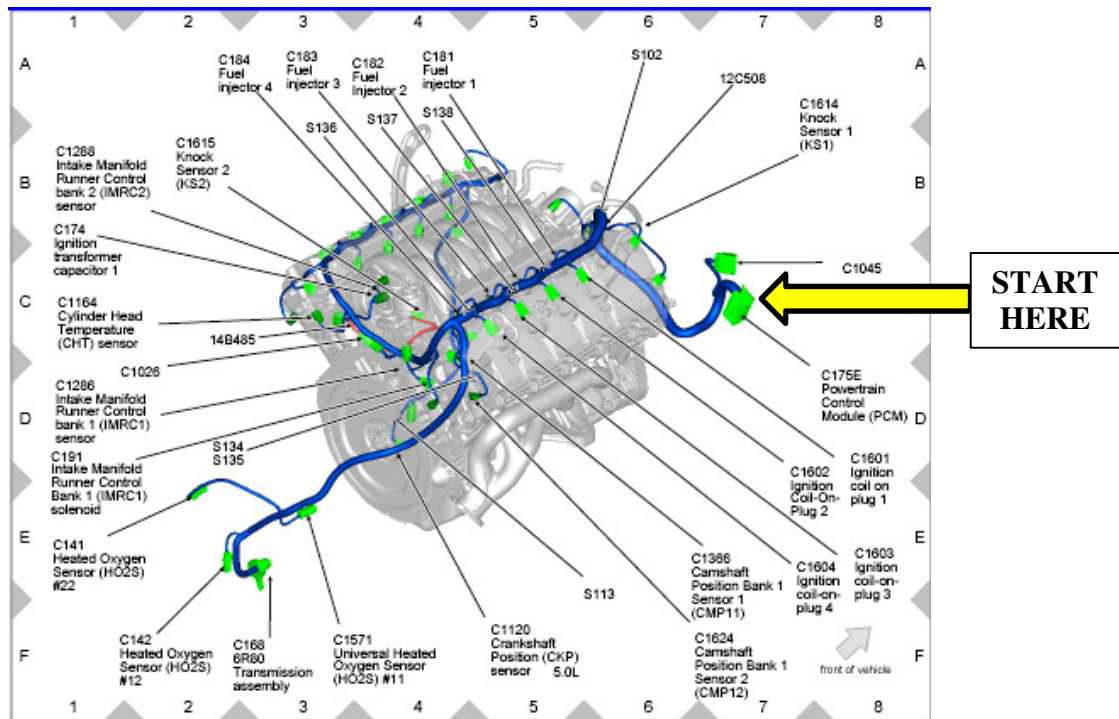

Figure 2 – Rear View of Engine.

Note: the wire harness shown in blue above is the ENGINE harness (FU5Z-12A587-E) that comes standard with the 5.0L 4V TiVCT NA Crate Engine (Ford Performance P/N: M-6007-M50A); THIS IS NOT THE CONTROLS PACK WIRING HARNESS.

Factory Ford shop manuals are available from Helm Publications, 1-800-782-4356



FORD PERFORMANCE

Instruction Sheet

M-6017-504V 5.0L Controls Pack

NO PART OF THIS DOCUMENT MAY BE REPRODUCED WITHOUT PRIOR AGREEMENT AND WRITTEN PERMISSION OF FORD RACING PERFORMANCE PARTS

Front View of Engine:

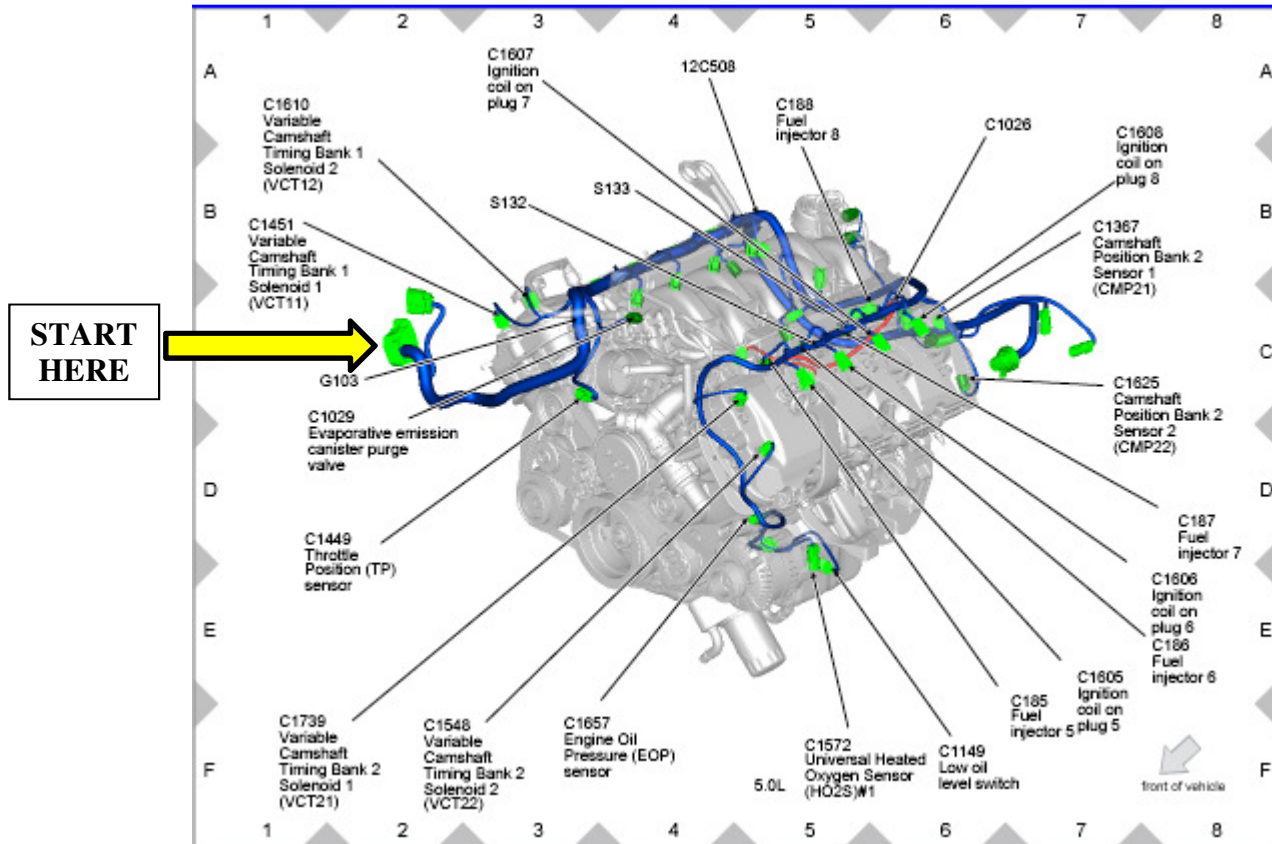

Figure 3 – Rear View of Engine.

Note: the wire harness shown in blue above is the ENGINE harness that comes standard with the 5.0L 4V TiVCT NA Crate Engine (Ford Performance P/N: M-6007-M50A); THIS IS NOT THE CONTROLS PACK WIRING HARNESS.

5.0 Controls Pack Harness Installation Instructions

NOTE: To avoid electrical shock and/or damage to sensitive electrical control system components, before beginning any work, remove the vehicle's Negative Battery Terminal and place a rag or towel between it and the Battery Negative Post. The Negative Battery Terminal is not to be reinstalled until the last step of installation.

1. Identify proper mounting location for the PCM, Power Distribution Box (Item C) & Inline Fuse Holder (Item W). Lay each component on its own piece of cardboard and use a pencil to create a template of the footprint. Use the templates to drill holes in the proper location/orientation within the vehicle engine compartment. Attach components to vehicle taking special care not to drop or bang the PCM against anything.
2. Locate the PCM connector (C175E) on the engine harness as indicated in Figures 2 and 3 by the "START HERE" arrow.
3. If a stock PCM is present (crate engines do NOT include a stock PCM, only the controls pack PCM), unplug it and store it in a cool, dry place in case it is needed in the future.

Factory Ford shop manuals are available from Helm Publications, 1-800-782-4356



FORD PERFORMANCE

Instruction Sheet

M-6017-504V 5.0L Controls Pack

NO PART OF THIS DOCUMENT MAY BE REPRODUCED WITHOUT PRIOR AGREEMENT AND WRITTEN PERMISSION OF FORD RACING PERFORMANCE PARTS

4. Plug C175E (from the engine harness) and C175B (Item T from the controls pack harness) into the controls pack PCM: FR3Z-12A650-EGC; once plugged-in, use a zip-tie to tie the bundle of wires exiting each connector back together. In the steps that follow, we will be repeating this process of using zip-ties to piggy-back/tie the controls pack harness to the existing engine harness approximately every 200 mm or so along the engine harness.
5. Moving away from the PCM connector on the controls pack harness (C175B), we reach the first wire split, which we'll refer to as "Takeout AA." Takeout AA is located approximately 150 mm from the PCM connectors and consists of 2 routings off of the main line:
 - a. Engine in-line connector routing (C146)
 - b. routing to follow the engine harness (leads to Takeout BB)
6. From Takeout AA, connect the in-line connector (C146) from the controls pack harness to the mating connector on the engine harness.
7. Route the second routing along the engine harness until it wraps around the rear of the engine, and then back up to the corner of the valve cover near the front of the engine being sure to "piggyback" to the engine harness every 200 mm or so; we'll refer to this location on the controls pack harness as "Takeout BB."
8. Takeout BB consists of three routings :
 - a. Alternator Connector (C102A)
 - b. Mass Air Flow (MAF) Sensor Connector (C128)
 - c. Intercooler connector for supercharger (C400)
 - i. Only used on supercharged vehicles; if not needed, follow removal procedures at end of this section. (*)
9. Connect each of the three connectors (if applicable) mentioned in Takeout BB to their respective locations being sure to avoid any pinch-points or exhaust hot-spots.
10. Located about 120 mm from Takeout AA, is what we'll call "Takeout CC," which has only one routing off of the main line. This routing leads to "Takeout CCA" and then to four different locations:
 - a. A/C Pressure Switch (C1260) ; if not needed, follow removal procedures at end of this section. (*)
 - b. A/C Clutch field (C100) ; if not needed, follow removal procedures at end of this section. (*)
 - c. Blunt-cut orange 10AWG wire to cooling fan
 - d. Starter Lead Eyelet
11. Connect each of the four connectors at Takeout CCA to their respective locations.
12. Approximately 3 feet down the main line, is "Takeout DD," which consists of 2 routings off of the main line:
 - a. PCM Power and Ground (C500)
 - b. Ford Performance Power Distribution Box (FPPDB)
13. Let connector C500 dangle freely for the time being; the FPPDB should already be mounted (Step 1), but we'll come back to it in Section 7 to complete installation.
14. Continuing down the main line away from Takeout DD, you should come across a loose/floating grommet. This grommet needs to be properly installed in the firewall of your vehicle so as to protect the controls pack harness routing that passes through to the passenger compartment. All Takeouts and connections previously mentioned are located under hood; all Takeouts and connections mentioned from this point on are located in the passenger compartment.
15. Identify the most appropriate location, based on your application, for the controls pack wiring harness to pass through the engine compartment/passenger compartment bulkhead. Use a center punch to mark the location of the center of the hole, this will keep the drill bit from 'walking' while you are cutting through the bulkhead. Next use a hole saw to create a hole large enough (~2") for the remaining portion of the controls pack harness to pass through. It is strongly recommended to file/smooth the sharp metal edges created by the hole saw and install a rubber grommet in the hole so as to prevent the metal edges from perforating the harness and causing damage to it. Feed the controls pack harness through the opening and route to the appropriate locations.
16. Identify proper mounting location for the Accelerator pedal, Clutch pedal (purchased separately) and Ignition Switch (purchased separately). Lay each component on its own piece of cardboard and use a pencil to create a template of the

Factory Ford shop manuals are available from Helm Publications, 1-800-782-4356



FORD PERFORMANCE

Instruction Sheet

M-6017-504V 5.0L Controls Pack

NO PART OF THIS DOCUMENT MAY BE REPRODUCED WITHOUT PRIOR AGREEMENT AND WRITTEN PERMISSION OF FORD RACING PERFORMANCE PARTS

footprint. Use the templates to drill holes in the proper location/orientation within the vehicle passenger compartment. Attach components to vehicle.

17. Identify mounting location for the Bracket with OBDII connector. Be sure to complete Step 16 before you do this as you will be limited by the harness lead length. Use a piece of paper or cardboard and a pencil to create a template of the bracket footprint. Use the template to drill holes in the proper location/orientation within the vehicle passenger compartment. Attach the bracket to the vehicle.
18. Moving down the main line of the controls pack harness from the loose grommet is "Takeout EE," which consists of one routing off of the mainline:
 - a. Ground eyelet for FPPDB
19. Connect the ground eyelet to a reliable ground point on the chassis or engine block, away from dirt and water.
20. Located approximately 1 foot down the main line of the controls pack harness from Takeout EE is "Takeout FF," which consists of one routing off of the mainline:
 - a. Instrument Panel Pigtail connector (C160A)
21. Route C160A to approximately the base of the steering wheel to be connected as explained in a later step (Step 26).
22. From Takeout FF, the only remaining routing takes us to "Takeout GG," which consists of one routing off of the mainline:
 - a. Accelerator Pedal Position Sensor (APPS) (C2040)
23. Connect C2040 to the base of the accelerator pedal module.
24. From Takeout GG, the only remaining routing takes us to "Takeout HH," which consists of four routings:
 - a. Clutch Bottom of Travel (C257)
 - b. Clutch Top of Travel (C277)
 - c. Data Link Connector (C251)
 - d. Ground eyelet for Data Link Connector; must be a reliable, clean, and dry ground.
25. Connect each of the connectors in Takeout HH to their respective locations.
26. Locate the 16-way I/P Pigtail connector with blunt leads (Item S) and continue to Section 6.

*** Removal Procedures for Unused Connectors:**

If 100% sure connector is not currently needed and will not be needed in the future, cut routing leading-up to unused connector and individually heat shrink each wire herein. To ensure that the wires are completely isolated from one another and the outside environment, you may also want to wrap the heat-shrunked wire in electrical tape to provide an additional layer of protection from moisture and dirt.

Factory Ford shop manuals are available from Helm Publications, 1-800-782-4356



FORD PERFORMANCE

Instruction Sheet

M-6017-504V 5.0L Controls Pack

NO PART OF THIS DOCUMENT MAY BE REPRODUCED WITHOUT PRIOR AGREEMENT AND WRITTEN PERMISSION OF FORD RACING PERFORMANCE PARTS

6.0 16-way I/P Pigtail Connection Details

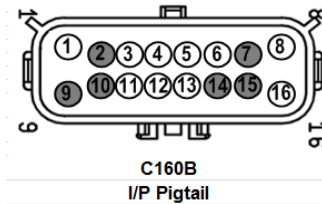
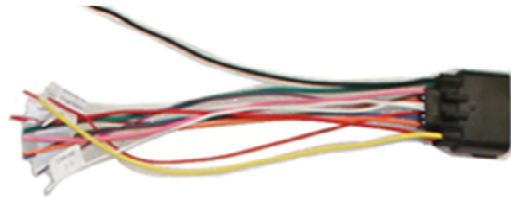

The 16-way pigtail is to be connected according to the chart below. See also the diagrams on the following pages for illustrations of wire connection points, based on the ignition/starter switches that you intend to use. Setup A uses separate toggle switches for ignition and starter inputs, while Setup B uses an ignition cylinder with a key.

Cavity	Lead Label	Wire Color	Description
1	Fuel Pump Relay Out	GN	Provides constant +12V to the fuel pump
2	AUX 1	BN	Optional use: provides constant +12V
3	Starter Motor Request (SMR)	Light Blue	Apply +12V to send a request to the PCM to energize the starter solenoid
4	Malfunction Indicator Lamp (MIL)	VT	Provides +12V to MIL when error state is present
5	Ignition Relay Trigger	Light Green	Apply +12V to energize the ignition relay/wake-up the system
6	A/C Request	BU	Apply +12V to send a request to the PCM to energize the A/C clutch solenoid
7	AUX 2	OG	Optional use: provides +12V when ignition is ON
8	HAAT B	RD	Provides constant +12V
9	Chassis Ground	BK	Provides ground for AUX 1-3, if needed
10	AUX 3	PK	Optional use: provides constant +12V
12	HS CAN (-)	WH	Provides access to High Speed CAN Bus (-) if needed
13	HS CAN (+)	WH-BU	Provides access to High Speed CAN Bus (+) if needed
16	Key On 12V/10A	YE	Provides +12V when ignition is ON

- 6.1 Locate each of the Blunt Leads. This is where you will need to make all of the soldered connections for the harness. Before soldering any wires, however, you must first decided which set-up you will pursue by referencing Set-up A and Set-up B on pages 19 and 20. Once you've decided on your set-up, continue to Step 6.2.
- 6.2 Connect the following REQUIRED blunt leads as follows:
 - 6.2.1 **Blunt Lead 1 – Fuel Pump Relay Out (Dark Green):** Connect to Fuel Pump positive. Separate ground for fuel pump must be provided. The fuel pump will be running any time key is on.
 - 6.2.2 **Blunt Lead 3 – Starter Motor Request (Light Blue):**

Set-up A:
Connect to input node of starter momentary switch so that 12 volts is provided when engine starting is requested.*

Set-up B:
Connect to 'Start' output node of ignition cylinder so that 12 volts is provided when engine starting is requested.*

Factory Ford shop manuals are available from Helm Publications, 1-800-782-4356



FORD PERFORMANCE

Instruction Sheet

M-6017-504V 5.0L Controls Pack

NO PART OF THIS DOCUMENT MAY BE REPRODUCED WITHOUT PRIOR AGREEMENT AND WRITTEN PERMISSION OF FORD RACING PERFORMANCE PARTS

- 6.2.3 **Blunt Lead 5 – Ignition Relay Trigger (Light Green):**
Set-up A:
Connect this wire to the output side of the ignition toggle switch so that 12 volts is provided when the key is in the 'Start' (cranking) and 'Run' positions. It is imperative that this circuit be reliable, the PCM will interpret an intermittent voltage on this signal as a request to shut down the engine! (Hint, if your engine shuts down after a hard launch check here first).
Set-up B:
Connect to the 'Start/Run' output node of ignition cylinder so that 12 volts is provided when engine starting is requested. It is imperative that this circuit be reliable, the PCM will interpret an intermittent voltage on this signal as a request to shut down the engine! (Hint, if your engine shuts down after a hard launch check here first).
- 6.2.4 **Blunt Lead 6 – Malfunction Indicator Light (Blue):** Connect this blunt lead to the negative (black) lead on the MIL (provided in the kit bag). You will need to provide 12V for the positive (red) lead of the MIL.
- 6.2.5 **Blunt Lead 8 – Hot At All Times (Red):**
Set-up A:
Connect this lead to three different locations as needed: 1) the input node of the A/C toggle switch, 2) the input node of the Starter momentary switch, and 3) the input node of the ignition toggle switch.
Set-up B:
Connect this lead to two different locations as needed: 1) the input node of the A/C toggle switch, 2) the input node of the ignition cylinder.
- 6.2.6 **Blunt Lead 9 – Chassis Ground (Black):** Connect this blunt lead to the negative (black) lead on the MIL (provided in the kit bag).
- 6.2.7 **Blunt Lead 16 – Key On 12V/10A (Yellow):**
Set-up A:
This lead is not needed and may be wrapped in heat shrink and electrical tape as described at the end of Section 5.
Set-up B:
Connect to the 'Accessory' output node of ignition cylinder so that 12 volts is provided when key is in 'Accessory/Run' mode with engine off.
- 6.3 Connect the following OPTIONAL blunt leads as follows:
- 6.3.1 **Blunt Lead 2 – AUX 1 (Brown):** Optional 12 volt power supply for additional aftermarket items. Please note that if use is desired, you must add an additional fuse to the FPPDB.
- 6.3.2 **Blunt Lead 4 – A/C Request (Violet):** Connect to the output of an A/C toggle switch (if desired). The other lead of the switch should be grounded. Sends a request to the PCM to energize the A/C Clutch Solenoid when switched on.
- 6.3.3 **Blunt Lead 7 – AUX 2 (Orange):** Optional 12 volt power supply for additional aftermarket items. Please note that if use is desired, you must add an additional fuse to the FPPDB.
- 6.3.4 **Blunt Lead 10 – AUX 3 (Pink):** Optional 12 volt power supply for additional aftermarket items. Please note that if use is desired, you must add an additional fuse to the FPPDB.
- 6.3.5 **Blunt Lead 12 – HS CAN (-) (White):** Optional CAN line for additional aftermarket items.
- 6.3.6 **Blunt Lead 13 – HS CAN (+) (White-Blue):** Optional CAN line for additional aftermarket items.
- 6.4 Once all of the blunt lead connections have been soldered onto their appropriate location, insert the 16-way I/P Pigtail connector into C160A.

Factory Ford shop manuals are available from Helm Publications, 1-800-782-4356



FORD PERFORMANCE

Instruction Sheet

M-6017-504V 5.0L Controls Pack

NO PART OF THIS DOCUMENT MAY BE REPRODUCED WITHOUT PRIOR AGREEMENT AND WRITTEN PERMISSION OF FORD RACING PERFORMANCE PARTS

* **Important Note on the Starting System**

This kit includes connections and installation instructions for PCM controlled engine starting; however, it is not required that the customer utilize this option. Customers may choose to use their existing non-PCM controlled starting system if desired. If non-PCM controlled starting is used, Step 6.2.2 may be omitted, and any unused blunt leads should be cut to ~2" length and sealed using heat shrink.

7.0 Ford Performance Power Distribution Box Installation

- 7.1. Locate the "B+ to FPPDB" cable discussed in Section 3.5. This cable was intentionally designed to be long enough to reach from the front to the rear of your vehicle to accommodate batteries located in the trunk. However, if your application does not require all of the provided length, you may choose to cut this cable shorter; if you do this, take extreme care to mimic the crimping and sealing quality used on the unaltered cable. If you choose to place your battery somewhere other than under-hood, you will need to drill a second hole (Similar to Step 15, Section 6) for the "B+ to FPPDB" cable to pass through.
- 7.2. Plug Item X (only connector on the "B+ to FPPDB" cable) into Item B (near Takeout DD and the FPPDB).
- 7.3. Attach Item Y to the power terminal on the side of the FPPDB (Item C) by tightening the nut down on top of the eyelet of Item Y. The order of install on the power terminal should be a washer, then the eyelet (Item Y), another washer, and then the nut.
- 7.4. From the FPPDB, route the "B+ to FPPDB" cable to the in-line fuse holder that you mounted in Step 1, avoiding sharp points and using zip-ties to secure the cable (approximately every 200 mm) along the way. **DO NOT CONNECT ANYTHING TO THE BATTERY YET.**
- 7.5. If present, remove the nut and washers on both terminals of the in-line fuse holder and set aside.
- 7.6. Place the Buss 250A fuse onto the fuse holder terminals.
- 7.7. Place the eyelet connector of Item W onto one of the two in-line fuse holder terminals, then one of the washers, and then tighten down with one of the two nuts.
- 7.8. On the opposite in-line fuse holder terminal, place one eyelet connector of the 4 AWG Jumper Cable (Item Z1), then the other remaining washer, and then tighten down with the remaining nut.
- 7.9. Close the cover of the in-line fuse holder.
- 7.10. Being careful not to inadvertently complete the circuit, connect the opposite end of the 4 AWG Jumper Cable (Item Z2) to the positive terminal of the vehicle battery.

Note: This lead **MUST** be hot at all times (HAAT). If this lead is connected through a switch, the Keep Alive Memory (KAM) of the PCM will be cleared whenever the switch is opened. This will result in loss of diagnostic trouble codes, adaptive fuel parameters, and other information stored in KAM by the PCM.

- 7.11. Using a screw, attach the ground eyelet (Item V) to the inner fender or bulkhead. Verify that you have a good reliable (dry and clean) ground path from the battery negative post to the location being used for this eyelet on the chassis. In general, the resistance from the battery ground to this chassis location should be less than 0.1 ohm.
- 7.12. Install and tighten the Negative Battery Terminal (not included in kit) onto the Vehicle Battery.

8.0 Fuel System

The PCM is calibrated for a return style fuel system as shown below.

- Set regulator to maintain 55 psi delta fuel pressure across injector (55 psi at fuel rail with engine off):
- Use only AN type fuel fitting to interface with OEM fuel rail.

Factory Ford shop manuals are available from Helm Publications, 1-800-782-4356



FORD PERFORMANCE

Instruction Sheet

M-6017-504V 5.0L Controls Pack

NO PART OF THIS DOCUMENT MAY BE REPRODUCED WITHOUT PRIOR AGREEMENT AND WRITTEN PERMISSION OF FORD RACING PERFORMANCE PARTS

- Fuel pressure regulator must have reference to manifold vacuum.

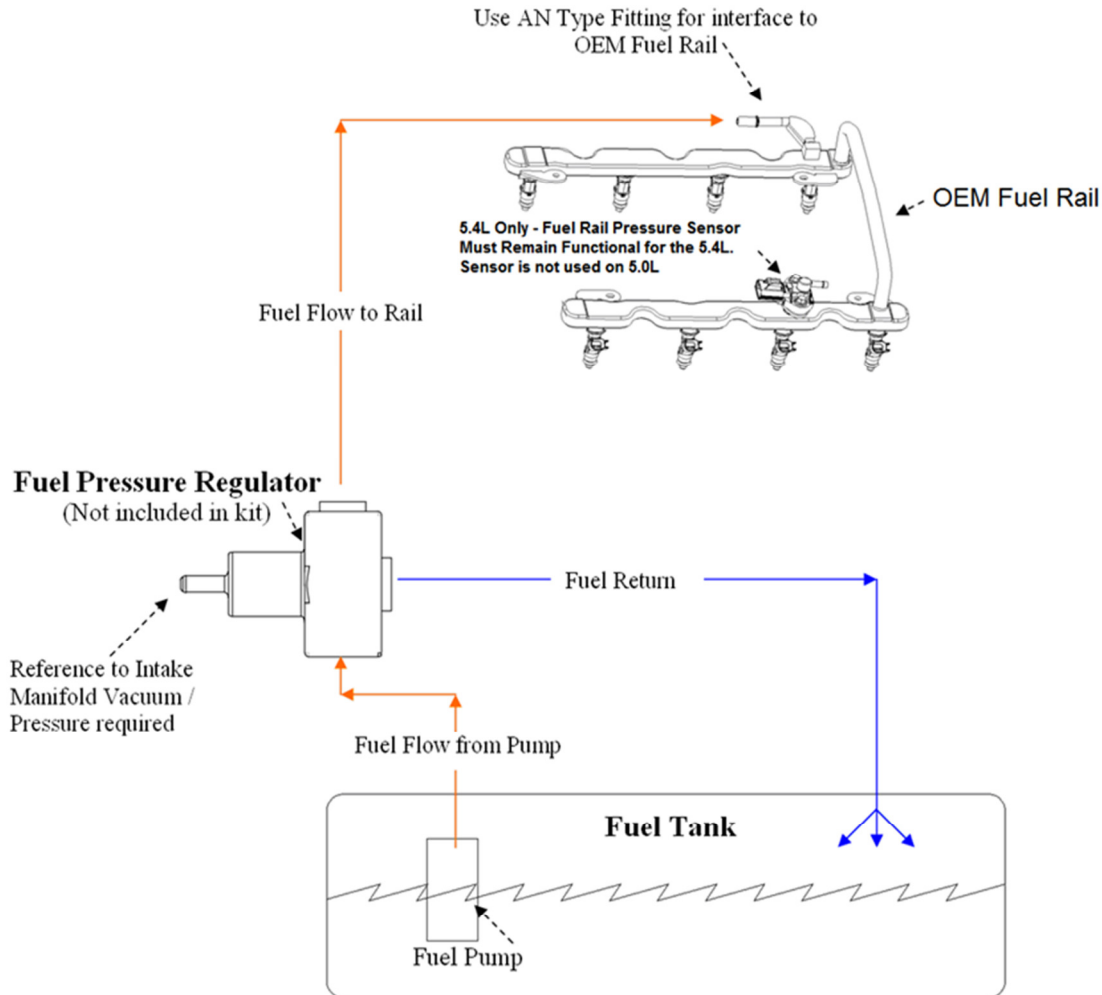

Fuel pump requirements: 155L/Hr minimum at 55psi

Fuel pump location

A common and often overlooked problem is the location of the fuel pump or pumps. Optimally, the fuel pump should be mounted IN THE TANK to reduce the possibility of pump cavitation. Cavitation is essentially localized boiling caused by a reduction in pressure, generally occurring on the inlet side of a pump. This localized boiling results in fuel vapor bubbles which will reduce the volume of fuel the pump is capable of delivering to the engine. Any reduction in pressure or increase in temperature at the inlet side of the pump increases the chances that cavitation will occur. For this reason, it is always best to either have the pump inside the tank immersed in fuel or (in the case of an external pump) gravity fed, which will increase the pressure on the inlet side of the pump. If the fuel pump has to "pull" the fuel, this will result in a reduction in pressure at the fuel pump inlet potentially allowing cavitation and, thus, vapor bubbles to develop. These vapor bubbles are then drawn into the fuel pump and exit the high-pressure side of the fuel pump as compressed vapor.

Factory Ford shop manuals are available from Helm Publications, 1-800-782-4356



FORD PERFORMANCE

Instruction Sheet

M-6017-504V 5.0L Controls Pack

NO PART OF THIS DOCUMENT MAY BE REPRODUCED WITHOUT PRIOR AGREEMENT AND WRITTEN PERMISSION OF FORD RACING PERFORMANCE PARTS

They travel the entire length of the fuel system and are expelled through the fuel injector. This can cause issues ranging from stumbles and hesitations to engine damage due to insufficient fuel delivery and lean A/F ratios. Sometimes this problem can

characterize itself by only appearing when the weather gets warmer, which can confound the diagnosis of the issue. In certain cases, it may seem to only develop when driving on certain surfaces, because pavement reflects more heat than an off-road 4x4 trail. Remember, more heat and lower pressure on the inlet side of the pump means a greater chance of cavitation, which is to be avoided whenever possible.

If you are using an external mounted fuel pump, you should run a very coarse (typically around 100 micron) filter on the inlet side of the fuel pump, and a finer (typically around 10 micron) filter on the outlet side of the pump. A paper filter is NOT recommended on the inlet of the fuel pump because it can cause a restriction in fuel flow which, as mentioned previously, can lead to cavitation.

Warning: It is highly recommended that an inertia switch is incorporated into the fuel pump wiring to turn off the fuel pump in event of an accident.

9.0 Initial Start-Up

Note: The following information assumes completion of each of the previous steps of this installation manual.

- 9.1. Check all fluid levels, electrical and fluid connections.
- 9.2. Pressurize the fuel system by turning the key on. Inspect the entire fuel system (from tank to engine) for leaks.

!!! NOTE: If any leaks are found, do not proceed further until these have been corrected !!!

- 9.3. Start Engine.
- 9.4. Check for leaks and/or noises that may indicate a problem.

CAUTION: Be certain to run the vehicle in a well ventilated area.

10.0 Wire Usage Schematics

The following two pages detail the two most common wiring configurations—please choose one to complete installation of your controls pack kit.

Factory Ford shop manuals are available from Helm Publications, 1-800-782-4356



FORD PERFORMANCE

Instruction Sheet

M-6017-504V 5.0L Controls Pack

NO PART OF THIS DOCUMENT MAY BE REPRODUCED WITHOUT PRIOR AGREEMENT AND WRITTEN PERMISSION OF FORD RACING PERFORMANCE PARTS

SETUP A

IGNITION



STARTER

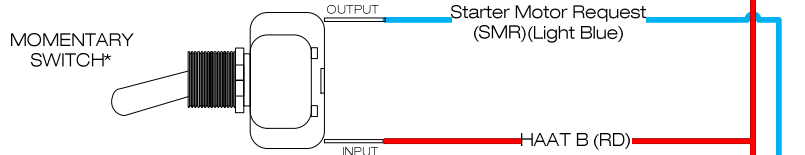

A/C

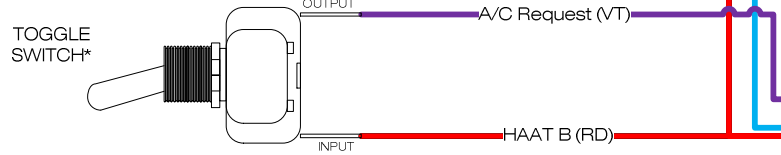

FUEL PUMP*

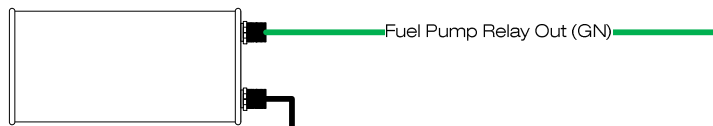

BATTERY*

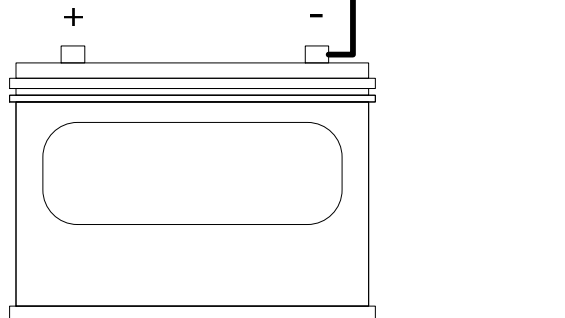

C160B

* = NOT INCLUDED

Factory Ford shop manuals are available from Helm Publications, 1-800-782-4356



FORD PERFORMANCE

Instruction Sheet

M-6017-504V 5.0L Controls Pack

NO PART OF THIS DOCUMENT MAY BE REPRODUCED WITHOUT PRIOR AGREEMENT AND WRITTEN PERMISSION OF FORD RACING PERFORMANCE PARTS

SETUP B

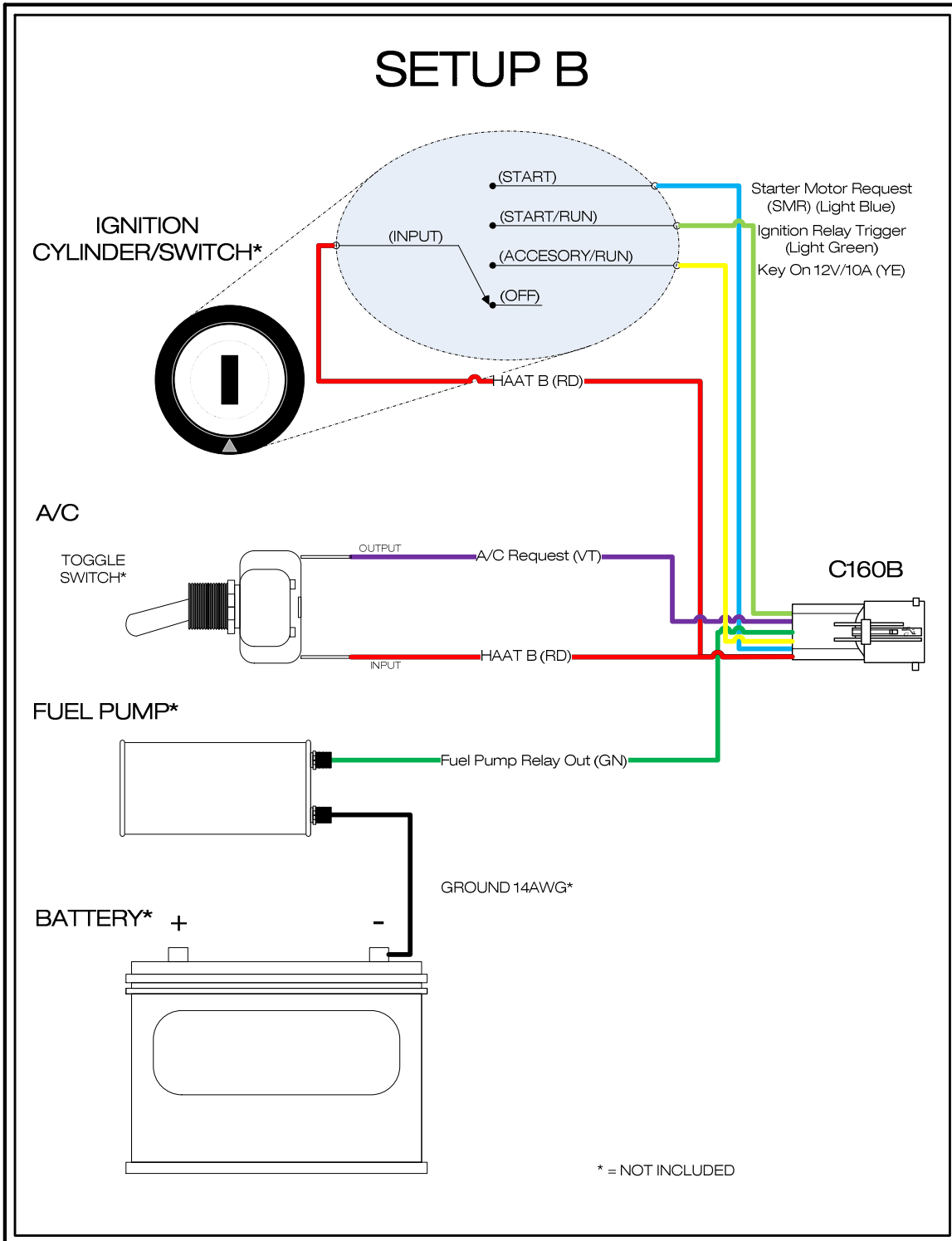

Factory Ford shop manuals are available from Helm Publications, 1-800-782-4356



FORD PERFORMANCE

Instruction Sheet

M-6017-504V 5.0L Controls Pack

NO PART OF THIS DOCUMENT MAY BE REPRODUCED WITHOUT PRIOR AGREEMENT AND WRITTEN PERMISSION OF FORD RACING PERFORMANCE PARTS

11.0 Fuses & Relays

- The following diagram outlines the array of fuses and relays included in the controls pack wiring harness, and the function of each.
- NOTE: Do NOT replace any of the fuses with a higher value than those specified below.

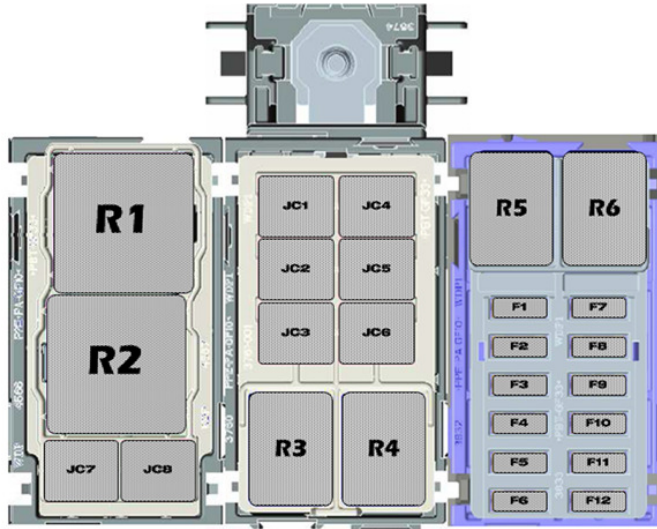

POWER DISTRIBUTION BOX (PDB)

Component ID	Type	Value	Name
JC1	J-Case Fuse	50A	PCM Relay Feed
JC2	J-Case Fuse	50A	Cooling Fan Relay Feed
JC3	J-Case Fuse	30A	Starter Relay Feed
JC4	J-Case Fuse	40A	Fuel Pump Relay Feed
JC5	J-Case Fuse	40A	Ignition Relay Feed
JC6	J-Case Fuse	NOT USED	AUX 1 HAAT
JC7	J-Case Fuse	NOT USED	NOT USED
JC8	J-Case Fuse	NOT USED	NOT USED
F1	Minifuse	20A	VPWR1
F2	Minifuse	20A	VPWR2
F3	Minifuse	15A	VPWR3
F4	Minifuse	15A	VPWR4
F5	Minifuse	10A	Ignition Switched A
F6	Minifuse	10A	Ignition Switched B
F7	Minifuse	15A	ICP
F8	Minifuse	NOT USED	AUX 2 HAAT
F9	Minifuse	10A	A/C Relay Feed
F10	Minifuse	10A	HAAT A
F11	Minifuse	10A	HAAT B
F12	Minifuse	NOT USED	AUX 3 HAAT
R1	Power Mini Relay	70A	PCM Relay
R2	Power Mini Relay	70A	Cooling Fan Relay
R3	High Current Micro Relay	40A	Starter Relay
R4	High Current Micro Relay	40A	Fuel Pump Relay
R5	High Current Micro Relay	40A	A/C Relay
R6	High Current Micro Relay	40A	Ignition Relay

12.0 Connector Faces

ALTERNATOR

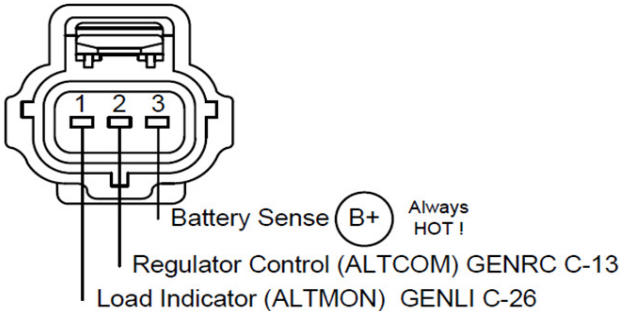

MAF/IAT Mass Air Flow Intake Air Temperature Sensor

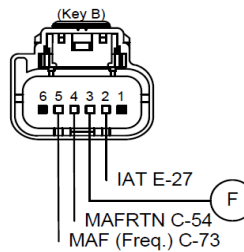

APPS Accelerator Pedal Position Sensor (Key A)

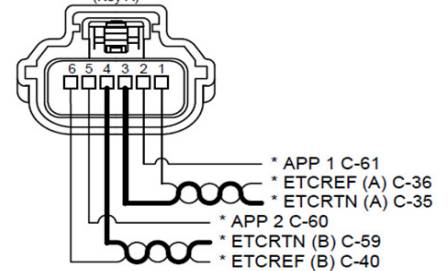

Factory Ford shop manuals are available from Helm Publications, 1-800-782-4356



FORD PERFORMANCE

Instruction Sheet

M-6017-504V 5.0L Controls Pack

NO PART OF THIS DOCUMENT MAY BE REPRODUCED WITHOUT PRIOR AGREEMENT AND WRITTEN PERMISSION OF FORD RACING PERFORMANCE PARTS

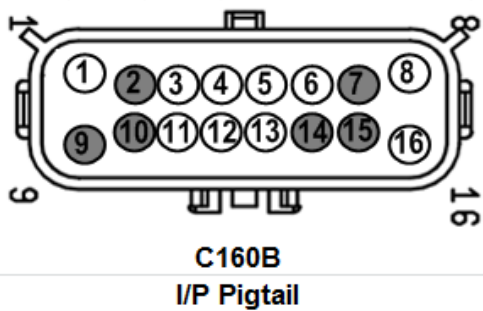
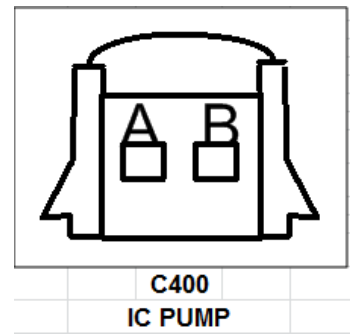
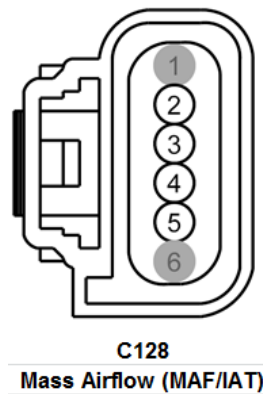
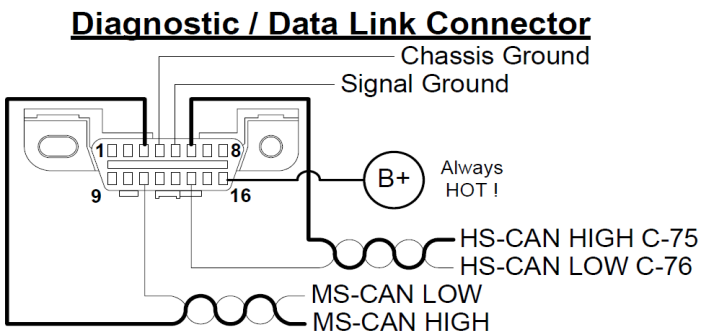
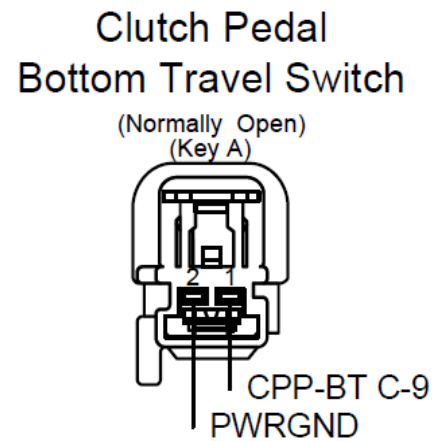
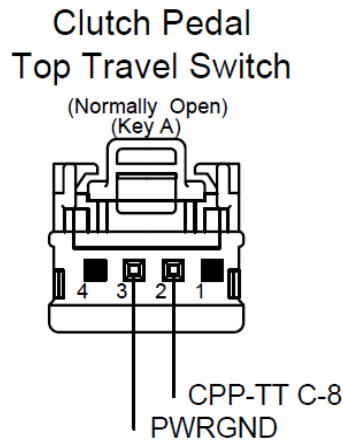
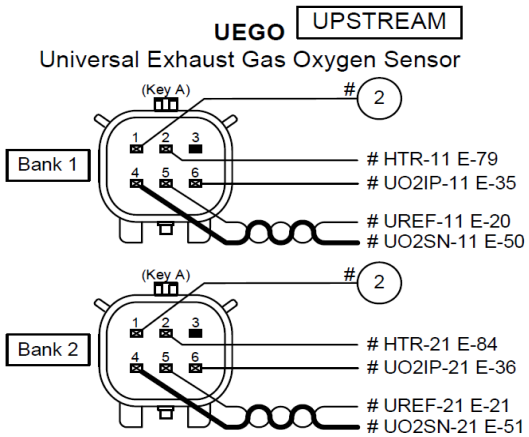

Factory Ford shop manuals are available from Helm Publications, 1-800-782-4356